

# JEE (Advanced) EXAMINATION - 2022 (Held on Sunday 28th August, 2022) PAPER - 1 Test Paper with Solution

## PHYSICS

### SECTION-1 : (Maximum Marks : 24)

- This section contains **EIGHT (08)** questions.
- The answer to each question is a **NUMERICAL VALUE**.
- For each question, enter the correct numerical value of the answer using the mouse and the on-screen virtual numeric keypad in the place designated to enter the answer. If the numerical value has more than two decimal places, **truncate/round-off** the value to **TWO** decimal places.
- Answer to each question will be evaluated according to the following marking scheme:  
*Full Marks* : +3 **ONLY** if the correct numerical value is entered;  
*Zero Marks* : 0 In all other cases.

1. Two spherical stars  $A$  and  $B$  have densities  $\rho_A$  and  $\rho_B$ , respectively.  $A$  and  $B$  have the same radius, and their masses  $M_A$  and  $M_B$  are related by  $M_B = 2M_A$ . Due to an interaction process, star  $A$  loses some of its mass, so that its radius is halved, while its spherical shape is retained, and its density remains  $\rho_A$ . The entire mass lost by  $A$  is deposited as a thick spherical shell on  $B$  with the density of the shell being  $\rho_A$ . If  $v_A$  and  $v_B$  are the escape velocities from  $A$  and  $B$  after the interaction process, the ratio  $\frac{v_B}{v_A} = \sqrt{\frac{10n}{15^{1/3}}}$ . The value of  $n$  is \_\_\_\_\_

**Ans. 2.30**

**Sol.** Given  $R_A = R_B = R$

$$M_B = 2M_A$$

Calculation of escape velocity for A:

$$\text{Radius of remaining star} = \frac{R_A}{2}$$

$$\text{Mass of remaining star} = \rho_A \frac{4}{3} \pi \frac{R_A^3}{8} = \frac{M_A}{8}$$

$$\frac{-GM_{A/B}}{R_{A/2}} + \frac{1}{2}mv_A^2 = 0 \Rightarrow v_A = \sqrt{\frac{2GM_{A/B}}{R_{A/2}}} = \sqrt{\frac{GM_A}{2R}}$$

Calculation of escape velocity for B

$$\text{Mass collected over B} = \frac{7}{8}M_A$$



Let the radius of B becomes  $r$ .

$$\therefore \frac{4}{3} \pi (r^3 - R_B^3) \rho_A = \frac{7}{8} \rho_A \frac{4}{3} \pi R_A^3 \Rightarrow \pi^3 = \frac{7}{8} R_A^3 + R_B^3 = \frac{(15)^{1/3} R}{2}$$

$$\therefore \frac{V_B^2}{2} = \frac{23GM_A}{8 \times 15^{1/3} \frac{R}{2}} = \frac{23GM_A}{4 \times 15^{1/3} R}$$

$$\therefore V_B = \sqrt{\frac{23GM_A}{2 \times 15^{1/3} R}}$$

$$\therefore \frac{V_B}{V_A} = \sqrt{\frac{23}{15^{1/3}}} = \sqrt{\frac{10 \times 2.30}{15^{1/3}}}$$

$$n = 2.30$$

2. The minimum kinetic energy needed by an alpha particle to cause the nuclear reaction  ${}^{16}_7\text{N} + {}^4_2\text{He} \rightarrow {}^1_1\text{H} + {}^{19}_8\text{O}$  in a laboratory frame is  $n$  (in  $\text{MeV}$ ). Assume that  ${}^{16}_7\text{N}$  is at rest in the laboratory frame. The masses of  ${}^{16}_7\text{N}$ ,  ${}^4_2\text{He}$ ,  ${}^1_1\text{H}$  and  ${}^{19}_8\text{O}$  can be taken to be  $16.006 u$ ,  $4.003 u$ ,  $1.008 u$  and  $19.003 u$ , respectively, where  $1 u = 930 \text{ MeV}c^{-2}$ . The value of  $n$  is \_\_\_\_\_.

**Ans. 2.32 to 2.33**

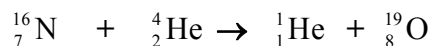
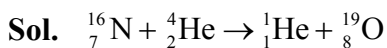

$$16.006 \quad 4.003 \quad 1.008 \quad 19.003$$

$$4v_0 = 1v_1 + 19v_2 = 20v_2 \quad (\text{For max loss of KE})$$

$$v_0 = \frac{v_2}{5}$$

$$E \text{ required} = (1.008 + 19.003 - 16.006 - 4.003) \times 930 = 1.86$$

$$\frac{1}{2} 4v_0^2 - \frac{1}{2} 20v_2^2 = 1.86$$

$$\frac{1}{2} 4v_0^2 - 10 \frac{v_0^2}{25} 20v_2^2 = 1.86$$

$$2v_0^2 - \frac{2}{5} v_0^2 = 1.86$$

$$\frac{8}{5} v_0^2 = 1.86$$

$$v_0^2 = \frac{1.86 \times 5}{8}$$

$$\text{KE} = \frac{1}{2} 4v_0^2 = 2v_0^2 = \frac{18.6 \times 5}{4}$$

$$= 2.325$$



3. In the following circuit  $C_1 = 12 \mu F$ ,  $C_2 = C_3 = 4 \mu F$  and  $C_4 = C_5 = 2 \mu F$ . The Charge stored in  $C_3$  is \_\_\_\_\_  $\mu C$ .

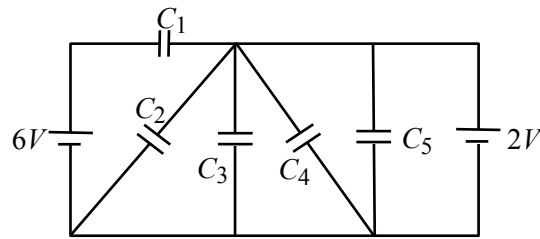

**Ans. 8**

**Sol.** Potential difference across the terminals of  $C_3$  is 2V.

$$\therefore Q_3 = CV = (4\mu)(2) = 8\mu C$$

4. A rod of length 2 cm makes an angle  $\frac{2\pi}{3}$  rad with the principal axis of a thin convex lens. The lens has a focal length of 10 cm and is placed at a distance of  $\frac{40}{3}$  cm from the object as shown in the figure. The height of the image is  $\frac{30\sqrt{3}}{13}$  cm and the angle made by it with respect to the principal axis is  $\alpha$  rad. The value of  $\alpha$  is  $\frac{\pi}{n}$  rad, where  $n$  is \_\_\_\_\_.

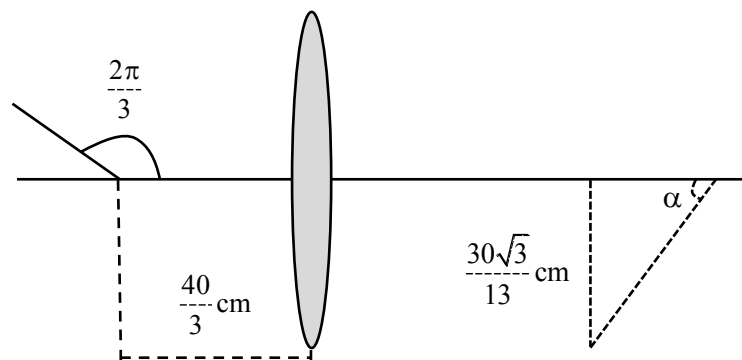

**Ans. 6**

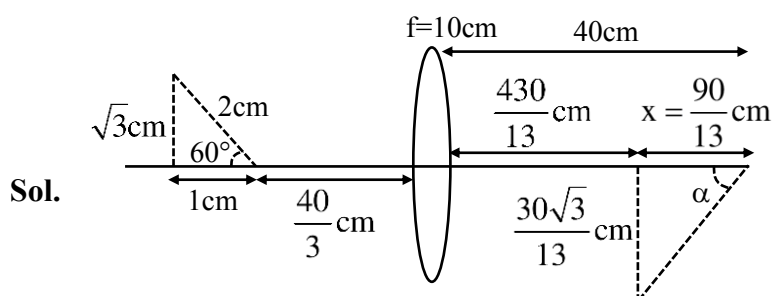

$$\frac{h_i}{h_0} = \frac{v}{u} \Rightarrow \frac{-\frac{30\sqrt{3}}{13}}{\frac{13}{\sqrt{3}}} = \frac{v}{-\frac{43}{3}} \Rightarrow v_1 = \frac{430}{13} \text{ cm}$$

$$* \frac{1}{v} - \frac{1}{u} = \frac{1}{f} \Rightarrow \frac{1}{v} = \frac{1}{10} - \frac{3}{40} \Rightarrow v = 40 \text{ cm}$$

$$* x = 40 - \frac{430}{13} = \frac{90}{13} \text{ cm}$$

$$\tan \alpha = \frac{\frac{30\sqrt{3}}{13}}{\frac{90}{13}} = \frac{1}{\sqrt{3}} \Rightarrow \alpha = 30^\circ = \frac{\pi}{6}$$

N = 6 Ans.

5. At time  $t = 0$ , a disk of radius  $1 \text{ m}$  starts to roll without slipping on a horizontal plane with an angular acceleration of  $\alpha = \frac{2}{3} \text{ rad s}^{-2}$ . A small stone is stuck to the disk. At  $t = 0$ , it is at the contact point of the disk and the plane. Later, at time  $t = \sqrt{\pi} \text{ s}$ , the stone detaches itself and flies off tangentially from the disk. The maximum height (in  $\text{m}$ ) reached by the stone measured from the plane is  $\frac{1}{2} + \frac{x}{10}$ . The value of  $x$  is \_\_\_\_\_. [Take  $g = 10 \text{ m s}^{-2}$ .]

Ans. 0.52

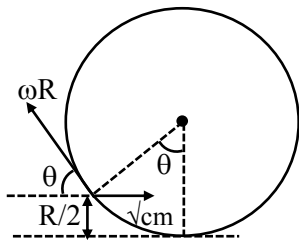

Sol.

At  $t = 0$ ,  $\omega = 0$

$$\text{at } t = \sqrt{\pi}, \omega = \alpha t = \frac{2}{3} \sqrt{\pi}, v = \omega r = \frac{2}{3} \sqrt{\pi}$$

$$\theta = \frac{1}{2} \alpha t^2$$

$$\theta = \frac{1}{2} \times \frac{2}{3} \times \pi = \frac{\pi}{3}$$

$$\theta = 60^\circ$$



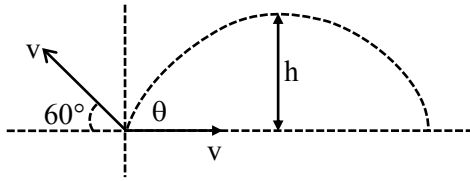

$$v_y = v \sin 60 = \frac{\sqrt{3}}{2} V$$

$$h = \frac{u_y^2}{2g} = \frac{\frac{3}{4}v^2}{2g}$$

$$h = \frac{\frac{3}{4} \times \frac{4}{9} \pi}{2g}$$

$$h = \frac{3\pi}{9 \times 2g} = \frac{\pi}{6g}$$

Maximum height from plane,  $H = \frac{R}{2} + h$

$$H = \frac{1}{2} + \frac{\pi}{6 \times 10}$$

$$x = \frac{\pi}{6}; x = 0.52$$

6. A solid sphere of mass  $1 \text{ kg}$  and radius  $1 \text{ m}$  rolls without slipping on a fixed inclined plane with an angle of inclination  $\theta = 30^\circ$  from the horizontal. Two forces of magnitude  $1 \text{ N}$  each, parallel to the incline, act on the sphere, both at distance  $r = 0.5 \text{ m}$  from the center of the sphere, as shown in the figure. The acceleration of the sphere down the plane is \_\_\_\_\_  $\text{ms}^{-2}$ . (Take  $g = 10 \text{ m s}^{-2}$ .)

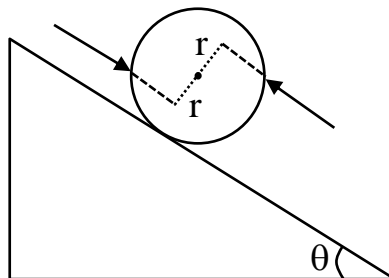

Ans. 2.85 to 2.86



**Sol.** Solid sphere 1kg, 1m

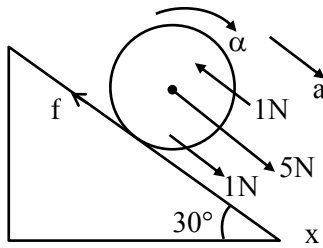

$$5 + 1 - 1 - f = 1a$$

$$5 - f = a$$

About COM

$$f \cdot 1 - 2(1(0.5)) = \frac{2}{5} Mr^2 \alpha$$

$$\Rightarrow f - 1 = \frac{2}{5} a \Rightarrow f = 1 + \frac{2}{5} a$$

$$5 - a = 1 + \frac{2}{5} a$$

$$\Rightarrow 4 = \frac{7a}{5} \Rightarrow a = \frac{20}{7} = 2.86 \text{ m/s}^2$$

7. Consider an LC circuit, with inductance  $L = 0.1 \text{ H}$  and capacitance  $C = 10^{-3} \text{ F}$ , kept on a plane. The area of the circuit is  $1 \text{ m}^2$ . It is placed in a constant magnetic field of strength  $B_0$  which is perpendicular to the plane of the circuit. At time  $t = 0$ , the magnetic field strength starts increasing linearly as  $B = B_0 + \beta t$  with  $\beta = 0.04 \text{ Ts}^{-1}$ . The maximum magnitude of the current in the circuit is \_\_\_ mA.

**Ans. 4**

**Sol.** Maximum energy will be

$$\frac{q_0^2}{2C} = \frac{1}{2} LI_0^2$$

$$\frac{q_0^2}{CL} = I_0^2$$

$$I_0 = \frac{q_0}{\sqrt{LC}}$$

$$I_0 = \frac{CV}{\sqrt{LC}}$$

$$I_0 = \sqrt{\frac{C}{L}} \times V \quad V = \text{emf} = \left| \frac{A dB}{dt} \right|$$



$$I_0 = \sqrt{\frac{10^{-3}}{0.1}} \times 0.04 \quad V = (1 \times 0.04)$$

Maximum current  $I_0 = 0.004 = 4\text{mA}$

**Ans. (4)**

8. A projectile is fired from horizontal ground with speed  $v$  and projection angle  $\theta$ . When the acceleration due to gravity is  $g$ , the range of the projectile is  $d$ . If at the highest point in its trajectory, the projectile enters a different region where the effective acceleration due to gravity is

$g' = \frac{g}{0.81}$ , then the new range is  $d' = nd$ . The value of  $n$  is \_\_\_\_\_.

**Ans. 0.95**

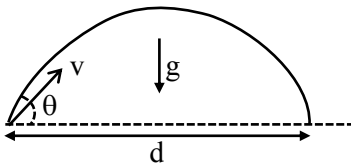

**Sol.**

$$d = \frac{v^2 \sin 2\theta}{g}$$

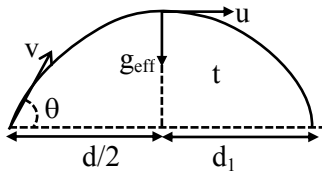

$$H_{\max} = \frac{v^2 \sin^2 \theta}{2g}; \quad \frac{1}{2} g_{\text{eff}} t^2 = H_{\max} \Rightarrow t^2 = \frac{2H_{\max}}{g_{\text{eff}}}; \quad t = \sqrt{\frac{v^2 \sin^2 \theta \times 0.81}{g^2}}; \quad t = \frac{0.9v \sin \theta}{g}$$

$$t^2 = \frac{2 \times v^2 \sin^2 \theta}{2g \left( \frac{g}{0.81} \right)}$$

$$d' = \text{New range} = \frac{d}{2} + d_1$$

$$d_1 = v \cos \theta \cdot t$$

$$= \frac{v^2 \sin^2 \theta \cos \theta \times 0.9}{g}; \quad d' = \frac{v^2 \sin 2\theta}{2g} + \frac{v^2 \sin 2\theta \times 0.9}{2g}$$

$$= \frac{v^2 \sin 2\theta}{g} \left( \frac{1.0}{2} \right) = 0.95d$$

$$n = 0.95$$



**SECTION-2 : (Maximum Marks : 24)**

- This section contains **SIX (06)** questions.
- Each question has **FOUR** options (A), (B), (C) and (D). **ONE OR MORE THAN ONE** of these four option(s) is (are) correct answer(s).
- For each question, choose the option(s) corresponding to (all) the correct answer(s).
- Answer to each question will be evaluated according to the following marking scheme:
 

<i>Full Marks</i>	: +4	<b>ONLY</b> if (all) the correct option(s) is(are) chosen;
<i>Partial Marks</i>	: +3	If all the four options are correct but <b>ONLY</b> three options are chosen;
<i>Partial Marks</i>	: +2	If three or more options are correct but <b>ONLY</b> two options are chosen, both of which are correct;
<i>Partial Marks</i>	: +1	If two or more options are correct but <b>ONLY</b> one option is chosen and it is a correct option;
<i>Zero Marks</i>	: 0	If none of the options is chosen (i.e. the question is unanswered);
<i>Negative Marks</i>	: -2	In all other cases.

9. A medium having dielectric constant  $K > 1$  fills the space between the plates of a parallel plate capacitor. The plates have large area, and the distance between them is  $d$ . The capacitor is connected to a battery of voltage  $V$ , as shown in Figure (a). Now, both the plates are moved by a distance of  $\frac{d}{2}$  from their original positions, as shown in Figure (b).

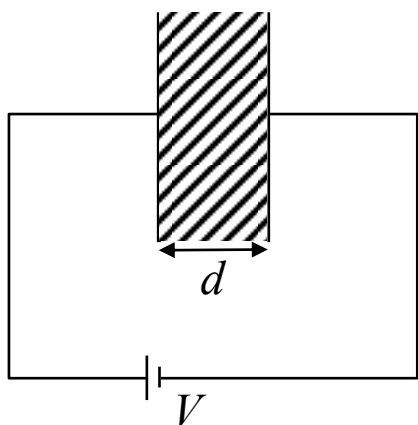

Figure (a)

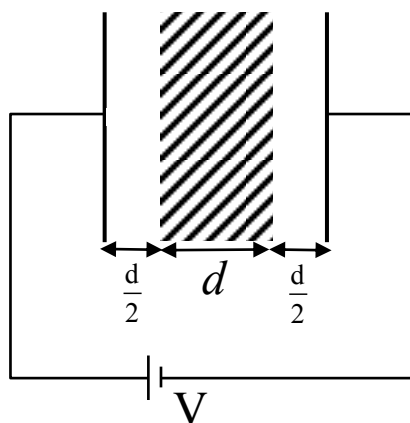

Figure (b)

In the process of going from the configuration depicted in Figure (a) to that in Figure (b), which of the following statement(s) is(are) correct?

- (A) The electric field inside the dielectric material is reduced by a factor of  $2K$ .
- (B) The capacitance is decreased by a factor of  $\frac{1}{K+1}$ .
- (C) The voltage between the capacitor plates is increased by a factor of  $(K+1)$ .
- (D) The work done in the process **DOES NOT** depend on the presence of the dielectric material.

**Ans. (B)**





Sol. For figure(a)

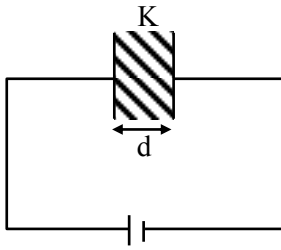

$$E_0 = \frac{V}{d}; C = \frac{K\epsilon_0 A}{d}$$

For figure(b)

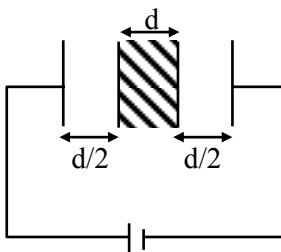

$$C' = \frac{\epsilon_0 A}{2d - d + d/k};$$

$$C' = \frac{K\epsilon_0 A}{(K+1)d}; C' = \frac{C}{K+1}$$

10. The figure shows a circuit having eight resistances of  $1 \Omega$  each, labelled  $R_1$  to  $R_8$ , and two ideal batteries with voltages  $\epsilon_1 = 12 V$  and  $\epsilon_2 = 6 V$ .

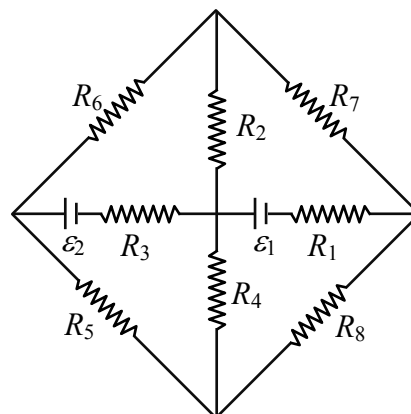

Which of the following statement(s) is(are) correct?

- (A) The magnitude of current flowing through  $R_1$  is  $7.2 A$ .
- (B) The magnitude of current flowing through  $R_2$  is  $1.2 A$ .
- (C) The magnitude of current flowing through  $R_3$  is  $4.8 A$ .
- (D) The magnitude of current flowing through  $R_5$  is  $2.4 A$ .

Ans. (A,B,C,D)



Sol.

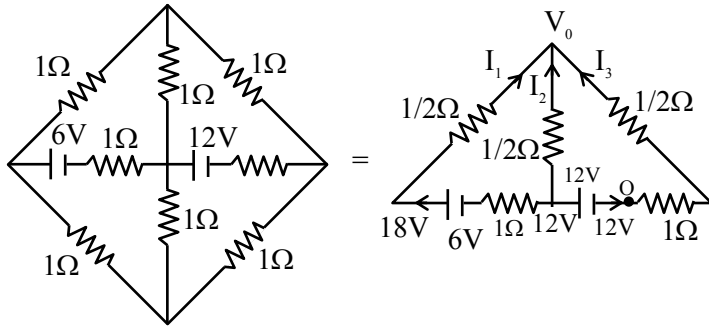

From KCL

$$i_1 + i_2 + i_3 = 0$$

$$\Rightarrow \frac{18 - V_0}{3/2} + \frac{12 - V_0}{1/2} + \frac{0 - V_0}{3/2} = 0$$

$$\Rightarrow 18 - V_0 + 36 - 3V_0 - V_0 = 0$$

$$\Rightarrow 54 = 5V_0$$

$$\frac{2\left(\frac{54}{5} - v'\right)}{1} + \frac{18 - v'}{1} = 0$$

$$\Rightarrow \frac{108}{5} + 18 = 3V'$$

$$\Rightarrow v' = \frac{198}{5 \times 3} = \frac{66}{5} \text{ V}$$

$$I_{R_1} = \frac{36}{5} = 7.2 \text{ A}$$

$$I_{R_2} = \frac{6}{5} = 1.2 \text{ A}$$

$$I_{R_3} = \frac{24}{5} = 4.8 \text{ A}$$

$$I_{R_5} = \frac{12}{5} = 2.4 \text{ A}$$



11. An ideal gas of density  $\rho = 0.2 \text{ kg m}^{-3}$  enters a chimney of height  $h$  at the rate of  $\alpha = 0.8 \text{ kg s}^{-1}$  from its lower end, and escapes through the upper end as shown in the figure. The cross-sectional area of the lower end is  $A_1 = 0.1 \text{ m}^2$  and the upper end is  $A_2 = 0.4 \text{ m}^2$ . The pressure and the temperature of the gas at the lower end are  $600 \text{ Pa}$  and  $300 \text{ K}$ , respectively, while its temperature at the upper end is  $150 \text{ K}$ . The chimney is heat insulated so that the gas undergoes adiabatic expansion. Take  $g = 10 \text{ ms}^{-2}$  and the ratio of specific heats of the gas  $\gamma = 2$ . Ignore atmospheric pressure.

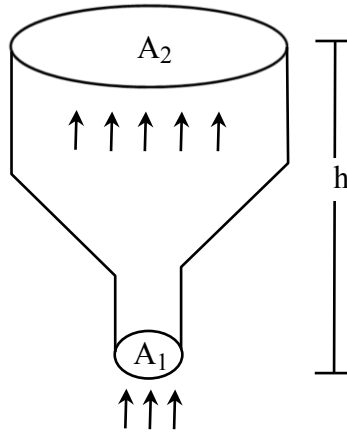

Which of the following statement(s) is(are) correct?

- (A) The pressure of the gas at the upper end of the chimney is  $300 \text{ Pa}$ .  
 (B) The velocity of the gas at the lower end of the chimney is  $40 \text{ ms}^{-1}$  and at the upper end is  $20 \text{ ms}^{-1}$ .  
 (C) The height of the chimney is  $590 \text{ m}$ .  
 (D) The density of the gas at the upper end is  $0.05 \text{ kg m}^{-3}$ .

Ans. (B)

Sol.

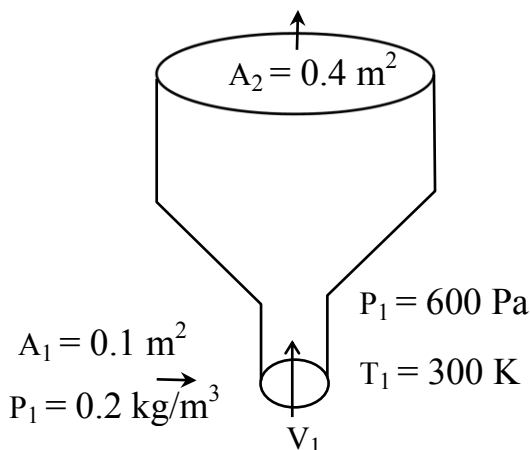

$$\frac{dm}{dt} = \rho_1 A_1 v_1 = 0.8 \text{ kg/s}$$

$$v_1 = \frac{0.8}{0.2 \times 0.1} = 40 \text{ m/s}$$



$$g = 10 \text{ m/s}^2$$

$$\gamma = 2$$

Gas undergoes adiabatic expansion,

$$p^{1-\gamma} T^\gamma = \text{Constant}$$

$$\frac{P_2}{P_1} = \left( \frac{T_1}{T_2} \right)^{\frac{\gamma}{1-\gamma}}$$

$$P_2 = \left( \frac{300}{150} \right)^{\frac{2}{-1}} \times 600$$

$$P_2 = \frac{600}{4} = 150 \text{ Pa}$$

$$\text{Now } \rho = \frac{PM}{RT} \Rightarrow \rho \propto \frac{P}{T}$$

$$\frac{\rho_1}{\rho_2} = \left( \frac{P_1}{P_2} \right) \left( \frac{T_1}{T_2} \right) = \left( \frac{150}{600} \right) \left( \frac{300}{150} \right) = \frac{1}{2}$$

$$\rho_2 = \frac{\rho_1}{2} = 0.1 \text{ kg/m}^3$$

$$\text{Now } \rho_2 A_2 v_2 = 0.8 \Rightarrow v_2 = \frac{0.8}{0.1 \times 0.4} = 20 \text{ m/s}$$

Now  $W_{\text{on gas}} = \Delta K + \Delta U + (\text{Internal energy})$

$$P_1 A_1 \Delta x_1 - P_2 A_2 \Delta x_2 = \frac{1}{2} \Delta m V_2^2 - \frac{1}{2} \Delta m V_1^2 + \Delta m g h + \frac{f}{2} (P_2 \Delta V_2 - P_1 \Delta V_1)$$

$$\Rightarrow 2P_1 \frac{\Delta V_1}{\Delta m} - 2P_2 \frac{\Delta V_2}{\Delta m} = \frac{V_2^2 - V_1^2}{2} + gh$$

$$\Rightarrow \frac{2 \times 600}{0.2} - \frac{2 \times 150}{0.1} = \frac{20^2 - 40^2}{2} + 10h$$

$$h = 360 \text{ m}$$



12. Three plane mirrors form an equilateral triangle with each side of length  $L$ . There is a small hole at a distance  $l > 0$  from one of the corners as shown in the figure. A ray of light is passed through the hole at an angle  $\theta$  and can only come out through the same hole. The cross section of the mirror configuration and the ray of light lie on the same plane.

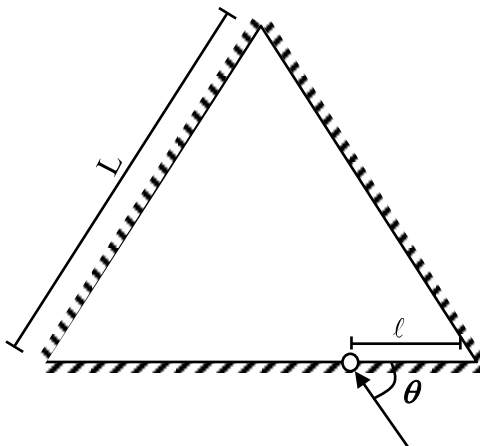

Which of the following statement(s) is(are) correct?

- (A) The ray of light will come out for  $\theta = 30^\circ$ , for  $0 < l < L$ .
- (B) There is an angle for  $l = \frac{L}{2}$  at which the ray of light will come out after two reflections.
- (C) The ray of light will **NEVER** come out for  $\theta = 60^\circ$ , and  $l = \frac{L}{3}$ .
- (D) The ray of light will come out for  $\theta = 60^\circ$ , and  $0 < l < \frac{L}{2}$  after six reflections.

Ans. (A,B)

Sol. (A) Ray will come out after one reflection for  $\theta = 30^\circ$  &  $0 < l < L$

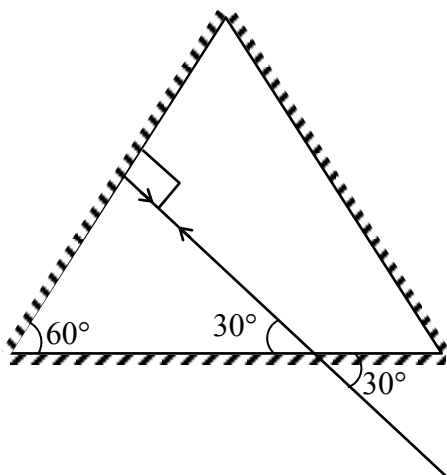

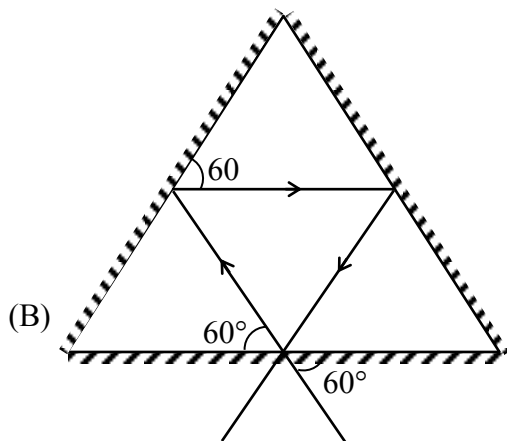

for  $\theta = 60^\circ$  &  $\ell = \frac{L}{2}$ , ray will come out after two reflections.

(C) For  $\ell = \frac{L}{3}$  &  $\theta = 60^\circ$  ray will come out after five reflections.

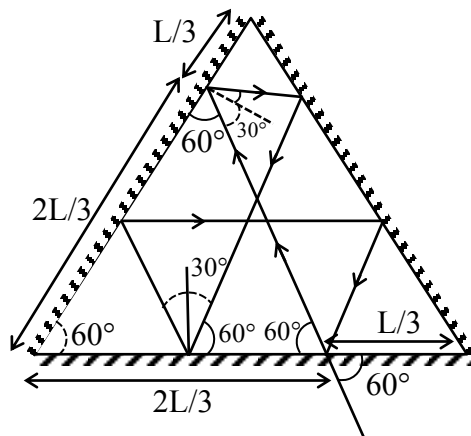

(D) For  $\theta = 60^\circ$  &  $0 < \ell < \frac{L}{2}$ , ray will come out after five reflections

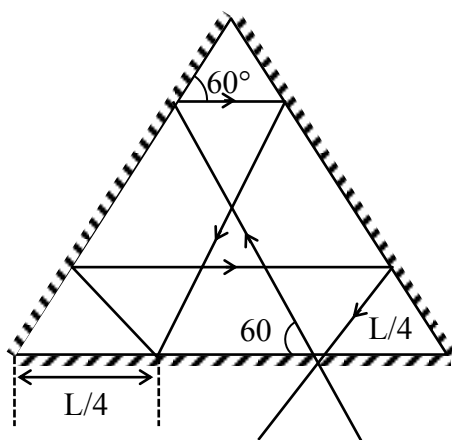

13. Six charges are placed around a regular hexagon of side length  $a$  as shown in the figure. Five of them have charge  $q$ , and the remaining one has charge  $x$ . The perpendicular from each charge to the nearest hexagon side passes through the center  $O$  of the hexagon and is bisected by the side.

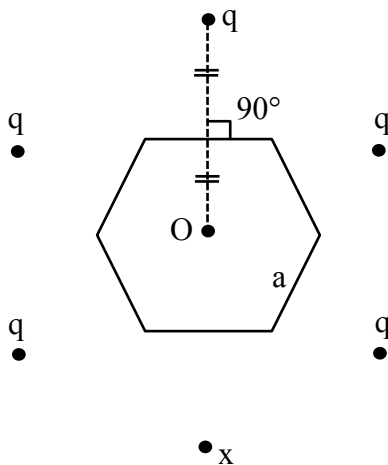

Which of the following statement(s) is(are) correct in SI units?

(A) When  $x = q$ , the magnitude of the electric field at  $O$  is zero.

(B) When  $x = -q$ , the magnitude of the electric field at  $O$  is  $\frac{q}{6\pi\epsilon_0 a^2}$ .

(C) When  $x = 2q$ , the potential at  $O$  is  $\frac{7q}{4\sqrt{3}\pi\epsilon_0 a}$ .

(D) When  $x = -3q$ , the potential at  $O$  is  $\frac{3q}{4\sqrt{3}\pi\epsilon_0 a}$ .

Ans. (A,B,C)

Sol. (A) Due to symmetry  $\vec{E}_0 = 0$

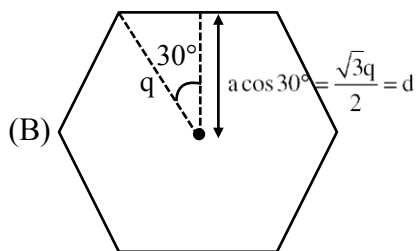

$$E_{\text{net}} = \frac{kq}{(2d)^2} \times 2 = \frac{2q \times 4}{4\pi\epsilon_0 \cdot 4 \cdot 3a^2}$$

$$= \frac{q}{6\pi\epsilon_0 a^2}$$

$$(C) \quad v = \frac{7kq}{2d} = \frac{7q}{4\pi\epsilon_0 \cdot \sqrt{3}a} = \frac{7q}{4\sqrt{3}\pi\epsilon_0 a}$$

$$(D) \quad v = \frac{2kq}{2d} = \frac{2q}{4\pi\epsilon_0 \cdot \sqrt{3}a} = \frac{q}{2\sqrt{3}\pi\epsilon_0 a}$$

Ans. (A,B,C)



14. The binding energy of nucleons in a nucleus can be affected by the pairwise Coulomb repulsion. Assume that all nucleons are uniformly distributed inside the nucleus. Let the binding energy of a proton be  $E_b^p$  and the binding energy of a neutron be  $E_b^n$  in the nucleus.

Which of the following statement(s) is(are) correct?

(A)  $E_b^p - E_b^n$  is proportional to  $Z(Z - 1)$  where  $Z$  is the atomic number of the nucleus.

(B)  $E_b^p - E_b^n$  is proportional to  $A^{-\frac{1}{3}}$  where  $A$  is the mass number of the nucleus.

(C)  $E_b^p - E_b^n$  is positive.

(D)  $E_b^p$  increases if the nucleus undergoes a beta decay emitting a positron.

**Ans. (A,B,D)**

**Sol.** Binding energy of proton & neutron due to nuclear force is same. So difference in binding energy is only due to electrostatic P.E. and it is positive

$$E_b^p - E_b^n = \text{electrostatic P.E.}$$

$$= Z \times \text{P.E. of one proton}$$

$$= Z \times \frac{1}{4\pi\epsilon_0} \frac{(Z-1)e^2}{R}$$

$$\text{Where } R = R_0 A^{1/3}$$

$$= \frac{1}{4\pi\epsilon_0} \frac{Z(Z-1)e^2}{R_0 A^{\frac{1}{3}}}$$

**Ans. (A,B,D)**





**SECTION-3 : (Maximum Marks : 12)**

- This section contains **FOUR (04)** Matching List Sets.
- Each set has **ONE** Multiple Choice Question.
- Each set has **TWO** lists : **List-I** and **List-II**.
- **List-I** has **Four** entries (I), (II), (III) and (IV) and **List-II** has **Five** entries (P), (Q), (R), (S) and (T).
- **FOUR** options are given in each Multiple Choice Question based on **List-I** and **List-II** and **ONLY ONE** of these four options satisfies the condition asked in the Multiple Choice Question.
- Answer to each question will be evaluated according to the following marking scheme:  
*Full Marks* : +3 **ONLY** if the option corresponding to the correct combination is chosen;  
*Zero Marks* : 0 If none of the options is chosen (i.e. the question is unanswered);  
*Negative Marks* : -1 In all other cases.

**15.** A small circular loop of area  $A$  and resistance  $R$  is fixed on a horizontal  $xy$ -plane with the center of the loop always on the axis  $\hat{n}$  of a long solenoid. The solenoid has  $m$  turns per unit length and carries current  $I$  counterclockwise as shown in the figure. The magnetic field due to the solenoid is in  $\hat{n}$  direction. List-I gives time dependences of  $\hat{n}$  in terms of a constant angular frequency  $\omega$ .

List-II gives the torques experienced by the circular loop at time  $t = \frac{\pi}{6\omega}$ , Let  $\alpha = \frac{A^2 \mu_0^2 m^2 I^2 \omega}{2R}$ .

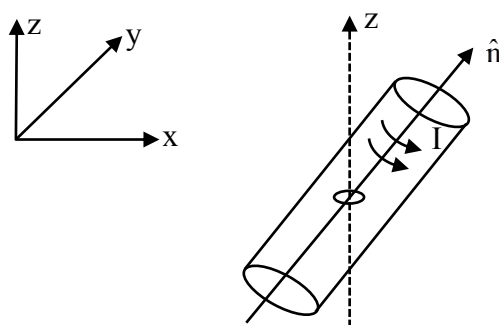

List-I		List-II	
(I)	$\frac{1}{\sqrt{2}}(\sin \omega t \hat{j} + \cos \omega t \hat{k})$	(P)	0
(II)	$\frac{1}{\sqrt{2}}(\sin \omega t \hat{i} + \cos \omega t \hat{j})$	(Q)	$-\frac{\alpha}{4} \hat{i}$
(III)	$\frac{1}{\sqrt{2}}(\sin \omega t \hat{i} + \cos \omega t \hat{k})$	(R)	$\frac{3\alpha}{4} \hat{i}$
(IV)	$\frac{1}{\sqrt{2}}(\cos \omega t \hat{i} + \sin \omega t \hat{k})$	(S)	$\frac{\alpha}{4} \hat{j}$
		(T)	$-\frac{3\alpha}{4} \hat{i}$

Which one of the following options is correct?

- (A) I→Q, II→P, III→S, IV→T                      (B) I→S, II→T, III→Q, IV→P  
 (C) I→Q, II→P, III→S, IV→R                      (D) I→T, II→Q, III→P, IV→R

**Ans. (C)**



**Sol.** (I)  $\vec{B} = \frac{\mu_0 m I}{\sqrt{2}} (\sin \omega t \hat{j} + \cos \omega t \hat{k})$

$$\phi = \vec{B} \cdot \vec{A} = \frac{\mu_0 m I}{\sqrt{2}} \cos(\omega t) \cdot A$$

$$\varepsilon = \frac{d\phi}{dt} = \frac{\mu_0 m I \omega A}{\sqrt{2}} \sin(\omega t)$$

$$i = \frac{\varepsilon}{R} = \frac{\mu_0 m I \omega A}{\sqrt{2} R} \sin(\omega t)$$

$$\vec{M} = i \vec{A} = i A (\hat{k}) = \frac{\mu_0 m I \omega A^2}{\sqrt{2} R} \sin(\omega t) (\hat{k})$$

$$\vec{\tau} = \vec{M} \times \vec{B} = \frac{\mu_0 m^2 I^2 \omega A^2}{\sqrt{2} R} \sin^2(\omega t) (-\hat{i})$$

$$= -\left(\frac{\alpha}{4}\right) \hat{i}$$

(II)  $\vec{B} = \frac{\mu_0 m I}{\sqrt{2}} (\sin \omega t \hat{i} + \cos \omega t \hat{j})$

$$\phi = 0, \varepsilon = 0, i = 0, t = 0$$

(III)  $\vec{B} = \frac{\mu_0 m I}{\sqrt{2}} (\sin \omega t \hat{i} + \cos \omega t \hat{k})$

$$\phi = \vec{B} \cdot \vec{A} = \frac{\mu_0 m I}{\sqrt{2}} \cdot \cos(\omega t) \cdot A$$

$$\varepsilon = -\frac{d\phi}{dt} = \frac{\mu_0 m I \omega A}{\sqrt{2}} \sin(\omega t)$$



$$i = \frac{\varepsilon}{R} = \frac{\mu_0 m I \omega A}{\sqrt{2R}} \sin(\omega t)$$

$$\vec{M} = i \vec{A} = i A (\hat{k}) = \frac{\mu_0 m I \omega A^2}{\sqrt{2R}} \sin(\omega t) (\hat{k})$$

$$\vec{\tau} = \vec{M} \times \vec{B} = \frac{\mu_0 m^2 I^2 \omega A^2}{2R} \sin^2(\omega t) (\hat{j})$$

$$= \frac{\alpha}{4} \hat{j}$$

$$(IV) \vec{B} = \frac{\mu_0 m I}{\sqrt{2}} (\cos \omega t \hat{j} + \sin \omega t \hat{k})$$

$$\phi = \vec{B} \cdot \vec{A} = \frac{\mu_0 m I}{\sqrt{2}} \cdot \sin(\omega t) \cdot A$$

$$\varepsilon = -\frac{d\phi}{dt} = \frac{\mu_0 m I \omega A}{\sqrt{2}} \cos(\omega t)$$

$$i = \frac{\varepsilon}{R} = -\frac{\mu_0 m I \omega A}{\sqrt{2R}} \cos(\omega t)$$

$$\vec{M} = i \vec{A} = i A (\hat{k}) = -\frac{\mu_0 m I \omega A^2}{\sqrt{2R}} \cos(\omega t) (\hat{k})$$

$$\vec{\tau} = \vec{M} \times \vec{B} = -\frac{\mu_0 m^2 I^2 \omega A^2}{2R} \cos^2(\omega t) (-\hat{i})$$

$$= \alpha \cdot \cos^2\left(\frac{\pi}{6}\right) \hat{i}$$

$$= \frac{3\alpha}{4} \hat{i}$$

**Ans. (C) I –Q, II-P, III-S, IV-R**

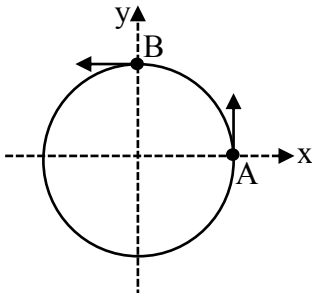
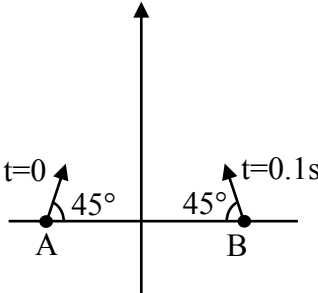
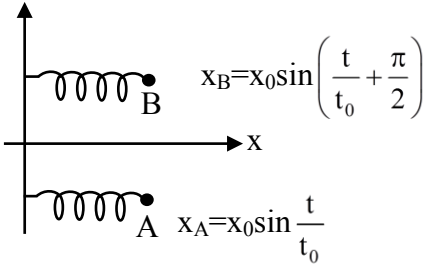

16. List I describes four systems, each with two particles  $A$  and  $B$  in relative motion as shown in figure. List II gives possible magnitudes of their relative velocities (in  $m s^{-1}$ ) at time  $t = \frac{\pi}{3} s$ .

List-I		List-II	
(I)	<p><math>A</math> and <math>B</math> are moving on a horizontal circle of radius <math>1 m</math> with uniform angular speed <math>\omega = 1 rad s^{-1}</math>. The initial angular positions of <math>A</math> and <math>B</math> at time <math>t = 0</math> are <math>\theta = 0</math> and <math>\theta = \frac{\pi}{2}</math> respectively.</p> 	(P)	$\frac{\sqrt{3}+1}{2}$
(II)	<p>Projectiles <math>A</math> and <math>B</math> are fired (in the same vertical plane) at <math>t = 0</math> and <math>t = 0.1 s</math> respectively, with the same speed <math>v = \frac{5\pi}{\sqrt{2}} m s^{-1}</math> and at <math>45^\circ</math> from the horizontal plane. The initial separation between <math>A</math> and <math>B</math> is large enough so that they do not collide, (<math>g = 10 m s^{-2}</math>).</p> 	(Q)	$\frac{(\sqrt{3}-1)}{\sqrt{2}}$
(III)	<p>Two harmonic oscillators <math>A</math> and <math>B</math> moving in the <math>x</math> direction according to <math>x_A = x_0 \sin \frac{t}{t_0}</math> and <math>x_B = x_0 \sin \left( \frac{t}{t_0} + \frac{\pi}{2} \right)</math> respectively, starting from <math>t = 0</math>. Take <math>x_0 = 1 m</math>, <math>t_0 = 1 s</math>.</p> 	(R)	$\sqrt{10}$

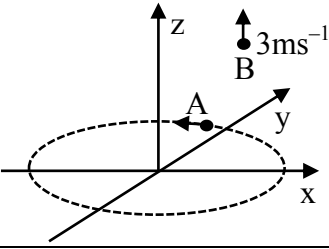

(IV)	Particle $A$ is rotating in a horizontal circular path of radius $1\text{ m}$ on the $xy$ plane, with constant angular speed $\omega = 1\text{ rad s}^{-1}$ . Particle $B$ is moving up at a constant speed $3\text{ m s}^{-1}$ in the vertical direction as shown in the figure. (Ignore gravity.) <div style="text-align: center;">  </div>	(S)	$\sqrt{2}$
		(T)	$\sqrt{25\pi^2 + 1}$

Which one of the following options is correct?

- (A) I  $\rightarrow$  R, II  $\rightarrow$  T, III  $\rightarrow$  P, IV  $\rightarrow$  S
- (B) I  $\rightarrow$  S, II  $\rightarrow$  P, III  $\rightarrow$  Q, IV  $\rightarrow$  R
- (C) I  $\rightarrow$  S, II  $\rightarrow$  T, III  $\rightarrow$  P, IV  $\rightarrow$  R
- (D) I  $\rightarrow$  T, II  $\rightarrow$  P, III  $\rightarrow$  R, IV  $\rightarrow$  S

**Ans. (C)**

**Sol.** (I)  $v_{BA}^2 = v_A^2 + v_B^2 - 2v_{AB} \cos \theta$

As  $\omega_A = \omega_B, \theta = 90^\circ$  remains constant.

Also,  $v_A = v_B = 1\text{ m/s}$

So,  $v_{BA} = \sqrt{2}\text{ m/s}$

(II)  $\vec{u}_A = \frac{5\pi}{2} \hat{i} + \frac{5\pi}{2} \hat{j}$

$\vec{v}_A = \frac{5\pi}{2} \hat{i} + \left( \frac{5\pi}{2} - 10 \cdot \frac{\pi}{3} \right) \hat{j}$

$= \frac{5\pi}{2} \hat{i} - \frac{5\pi}{6} \hat{j}$

$\vec{u}_B = -\frac{5\pi}{2} \hat{i} + \frac{5\pi}{2} \hat{j}$



$$\vec{u}_B = -\frac{5\pi}{2}\hat{i} - \left(\frac{5\pi}{6} + 1\right)\hat{j}$$

$$\vec{v}_{B,A} = -5\pi\hat{i} - \hat{j}$$

$$v_{BA} = \sqrt{25\pi^2 + 1}$$

$$(III) x_A = \sin t$$

$$v_A = \cos t = \frac{1}{2} \text{ m/s}$$

$$x_B = \cos t$$

$$v_B = -\sin t = -\frac{\sqrt{3}}{2} \text{ m/s}$$

$$v_{BA} = -\frac{\sqrt{3}}{2} - \frac{1}{2}$$

(IV)  $\vec{v}_A$  &  $\vec{v}_B$  are always perpendicular

$$\text{So, } |\vec{v}_{BA}| = \sqrt{v_A^2 + v_B^2} = \sqrt{10} \text{ m/s}$$

Ans. (C), I-S, II-T, III-P, IV-R

17. List I describes thermodynamic processes in four different systems. List II gives the magnitudes (either exactly or as a close approximation) of possible changes in the internal energy of the system due to the process.

List-I		List-II	
(I)	$10^{-3}$ kg of water at $100^\circ\text{C}$ is converted to steam at the same temperature, at a pressure of $10^5 \text{ Pa}$ . The volume of the system changes from $10^{-6} \text{ m}^3$ to $10^{-3} \text{ m}^3$ in the process. Latent heat of water = $2250 \text{ kJ/kg}$ .	(P)	$2 \text{ kJ}$
(II)	0.2 moles of a rigid diatomic ideal gas with volume $V$ at temperature $500 \text{ K}$ undergoes an isobaric expansion to volume $3V$ . Assume $R = 8.0 \text{ J mol}^{-1} \text{ K}^{-1}$ .	(Q)	$7 \text{ kJ}$
(III)	One mole of a monatomic ideal gas is compressed adiabatically from volume $V = \frac{1}{3} \text{ m}^3$ and pressure $2 \text{ kPa}$ to volume $\frac{V}{8}$ .	(R)	$4 \text{ kJ}$
(IV)	Three moles of a diatomic ideal gas whose molecules can vibrate, is given $9 \text{ kJ}$ of heat and undergoes isobaric expansion.	(S)	$5 \text{ kJ}$
		(T)	$3 \text{ kJ}$

Which one of the following options is correct ?

(A) I  $\rightarrow$  T, II  $\rightarrow$  R, III  $\rightarrow$  S, IV  $\rightarrow$  Q

(B) I  $\rightarrow$  S, II  $\rightarrow$  P, III  $\rightarrow$  T, IV  $\rightarrow$  P

(C) I  $\rightarrow$  P, II  $\rightarrow$  R, III  $\rightarrow$  T, IV  $\rightarrow$  Q

(D) I  $\rightarrow$  Q, II  $\rightarrow$  R, III  $\rightarrow$  S, IV  $\rightarrow$  T

Ans. (C)



**Sol.** (I)  $\Delta U = \Delta Q - \Delta W$

$$= \left\{ (10^{-3} \times 2250) - \frac{10^5 (10^{-3} - 10^{-6})}{10^3} \right\} \text{kJ}$$

$$= (2.25 - 0.0999) \text{kJ}$$

$$= (2.1501) \text{kJ}$$

(II)  $\Delta U = nC_V \Delta T$

$$= \frac{5}{2} nR \Delta T$$

$$= \frac{5}{2} \cdot (0.2)(8)(1500 - 500) \text{J}$$

$$= 4 \text{ kJ}$$

(III)  $P_1 V_1^\gamma = P_2 V_2^\gamma$

$$\Rightarrow 2 \left( \frac{1}{3} \right)^{5/3} = P_2 \left( \frac{1}{24} \right)^{5/3}$$

$$\Rightarrow P_2 = 64 \text{ kPa}$$

$$\Delta U = nC_V \Delta T = \frac{3}{2} \cdot (P_2 V_2 - P_1 V_1)$$

$$= \frac{3}{2} \left( 64 \times \frac{1}{24} - 2 \times \frac{1}{3} \right) \text{kJ}$$

$$= 3 \text{ kJ}$$

(IV)  $\Delta U = nC_V \Delta T$

$$= n \cdot \frac{7}{2} R \Delta T$$

$$= \frac{7}{9} \Delta Q$$

$$= 7 \text{ kJ}$$

**Ans. (C); I-P, II-R, III-T, IV-Q**



18. List I contains four combinations of two lenses (1 and 2) whose focal lengths (in cm) are indicated in the figures. In all cases, the object is placed 20 cm from the first lens on the left, and the distance between the two lenses is 5 cm. List II contains the positions of the final images.

List-I		List-II	
(I)		(P)	Final image is formed at 7.5 cm on the right side of lens 2.
(II)		(Q)	Final image is formed at 60.0 cm on the right side of lens 2.
(III)		(R)	Final image is formed at 30.0 cm on the left side of lens 2.
(IV)		(S)	Final image is formed at 6.0 cm on the right side of lens 2.
		(T)	Final image is formed at 30.0 cm on the right side of lens 2.

Which one of the following options is correct ?

- (A) I → P, II → R, III → Q, IV → T  
 (B) I → Q, II → P, III → T, IV → S  
 (C) I → P, II → T, III → R, IV → Q  
 (D) I → T, II → S, III → Q, IV → R

Ans. (A)





**Sol.** (I)  $v_1 = \frac{uf}{u+f}$

$$= \frac{(-20)(10)}{(-20)+(10)} = +20$$

$$u_2 = +15$$

$$v_2 = \frac{(15)(15)}{(15)+(15)} = +7.5$$

(II)  $v_1 = +20$

$$u_2 = +15$$

$$v_2 = \frac{(15)(-10)}{(15)+(-10)} = -30$$

(III)  $v_1 = +20$

$$u_2 = +15$$

$$v_2 = \frac{(15)(-20)}{(15)+(-20)} = 60$$

(IV)  $v_1 = \frac{(-20)(-20)}{(-20)+(-20)} = -10$

$$u_2 = -15$$

$$v_2 = \frac{(-15)(10)}{(-15)+(10)} = 30$$

**Ans. (A), I-P, II-R, III-Q, IV-T**



# CHEMISTRY

## SECTION-1 : (Maximum Marks : 24)

- This section contains **EIGHT (08)** questions.
  - The answer to each question is a **NUMERICAL VALUE**.
  - For each question, enter the correct numerical value of the answer using the mouse and the on-screen virtual numeric keypad in the place designated to enter the answer. If the numerical value has more than two decimal places, **truncate/round-off** the value to **TWO** decimal places.
  - Answer to each question will be evaluated according to the following marking scheme:  
*Full Marks* : +3 **ONLY** if the correct numerical value is entered;  
*Zero Marks* : 0 In all other cases.
- 

1. 2 mol of Hg(g) is combusted in a fixed volume bomb calorimeter with excess of O<sub>2</sub> at 298 K and 1 atm into HgO(s). During the reaction, temperature increases from 298.0 K to 312.8 K. If heat capacity of the bomb calorimeter and enthalpy of formation of Hg(g) are 20.00 kJ K<sup>-1</sup> and 61.32 kJ mol<sup>-1</sup> at 298 K, respectively, the calculated standard molar enthalpy of formation of HgO(s) at 298 K is X kJ mol<sup>-1</sup>. The value of |X| is \_\_\_\_\_.
- [Given : Gas constant R = 8.3 J K<sup>-1</sup> mol<sup>-1</sup>]

**Ans. (90.39)**

**Sol.**  $Q_{\text{rxn}} = C\Delta T$

$$|\Delta U| \times 2 = 20 \times 14.8$$

$$|\Delta U| = 148 \text{ kJ/mol}$$

$$\Delta U = -148 \text{ kJ/mol}$$



$$\Delta H = \Delta U + \Delta n_g RT$$

$$= -148 - \frac{3}{2} \times \frac{8.3}{1000} \times 298 = -151.7101$$

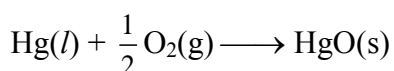

$$\Delta H = -151.7101 + 61.32 = -90.39 \text{ kJ/mol}$$

Ans. 90.39



2. The reduction potential ( $E^0$ , in V) of  $\text{MnO}_4^- (\text{aq})/\text{Mn(s)}$  is \_\_\_\_\_.

[Given :  $E^0_{(\text{MnO}_4^- (\text{aq})/\text{MnO}_2 (\text{s}))} = 1.68\text{V}$  ;  $E^0_{(\text{MnO}_2 (\text{s})/\text{Mn}^{2+} (\text{aq}))} = 1.21\text{V}$  ;  $E^0_{(\text{Mn}^{2+} (\text{aq})/\text{Mn(s)})} = -1.03\text{V}$  ]

**Ans. (0.77)**

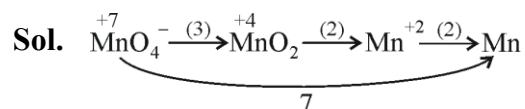

For the required reaction  $\Delta G^\circ = \Delta G^\circ_1 + \Delta G^\circ_2 + \Delta G^\circ_3$

$$\Rightarrow 7 \times E = 1.68 \times 3 + 1.21 \times 2 + (-1.03) \times 2$$

$$E = \frac{5.4}{7} = 0.7714$$

Ans. = 0.77

3. A solution is prepared by mixing 0.01 mol each of  $\text{H}_2\text{CO}_3$ ,  $\text{NaHCO}_3$ ,  $\text{Na}_2\text{CO}_3$ , and  $\text{NaOH}$  in 100 mL of water. pH of the resulting solution is \_\_\_\_\_.

[Given :  $pK_{a1}$  and  $pK_{a2}$  of  $\text{H}_2\text{CO}_3$  are 6.37 and 10.32, respectively ;  $\log 2 = 0.30$ ]

**Ans. (10.02)**

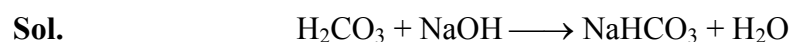

Milli moles	10	10	—
-------------	----	----	---

At end	0	0	$10 + 10 = 20$
--------	---	---	----------------

Final mixture has 20 milli moles  $\text{NaHCO}_3$  and 10 milli moles  $\text{Na}_2\text{CO}_3$

$$\text{pH} = \text{p}K_{a2} + \log \frac{\text{Salt}}{\text{Acid}}$$

$$\text{pH} = \text{p}K_{a2} + \log \left( \frac{10}{20} \right) \quad [\text{Buffer} : \text{Na}_2\text{CO}_3 + \text{NaHCO}_3]$$

$$= 10.32 - \log 2 = 10.02$$

4. The treatment of an aqueous solution of 3.74 g of  $\text{Cu}(\text{NO}_3)_2$  with excess  $\text{KI}$  results in a brown solution along with the formation of a precipitate. Passing  $\text{H}_2\text{S}$  through this brown solution gives another precipitate X. The amount of X (in g) is \_\_\_\_\_.

[Given : Atomic mass of H = 1, N = 14, O = 16, S = 32, K = 39, Cu = 63, I = 127]

**Ans. (0.32)**

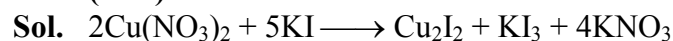

0.02		0.01	
------	--	------	--

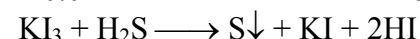

0.01	0.01		
------	------	--	--

$$n_S = 0.01 \text{ mole}$$

$$\text{weight of sulphur} = 32 \times 0.01 = 0.32 \text{ gm}$$



5. Dissolving 1.24 g of white phosphorous in boiling NaOH solution in an inert atmosphere gives a gas **Q**. The amount of  $\text{CuSO}_4$  (in g) required to completely consume the gas **Q** is \_\_\_\_\_.

[Given : Atomic mass of H = 1, O = 16, Na = 23, P = 31, S = 32, Cu = 63]

Ans. (2.38 / 2.39)

Sol. Mole of  $\text{P}_4 = \frac{1.24}{31 \times 4} = 0.01$

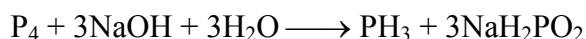

$$0.01 \text{ mole} \qquad \qquad \qquad 0.01 \text{ mole}$$

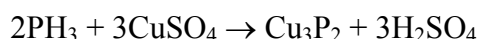

$$0.01 \quad \frac{3}{2} \times 0.01$$

$$= \frac{0.03}{2} \text{ moles}$$

$$W_{\text{CuSO}_4} = \frac{0.03}{2} \times 159 = 2.385 \text{ gm}$$

Ans. = 2.38 or 2.39

6. Consider the following reaction.

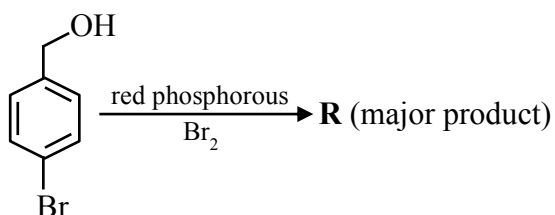

On estimation of bromine in 1.00 g of **R** using Carius method, the amount of  $\text{AgBr}$  formed (in g) is \_\_\_\_\_.

[Given : Atomic mass of H = 1, C = 12, O = 16, P = 31, Br = 80, Ag = 108]

Ans. (1.50)

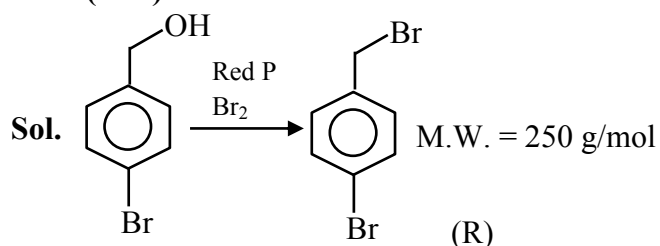

$$1 \text{ g R} \rightarrow \frac{1}{250} \text{ moles}$$

$$\text{No. of Br Atoms} \rightarrow \frac{2}{250} \text{ moles}$$

$$\text{Moles of AgBr} \rightarrow \frac{2}{250} \text{ moles}$$

$$\text{Mass of AgBr} = \frac{2}{250} \times (108 + 80) = 1.504$$



7. The weight percentage of hydrogen in **Q**, formed in the following reaction sequence, is \_\_\_\_\_.

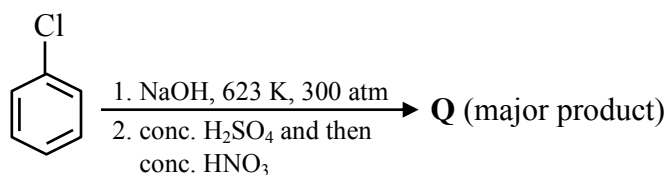

[Given : Atomic mass of H = 1, C = 12, N = 14, O = 16, S = 32, Cl = 35]

Ans. (1.31)

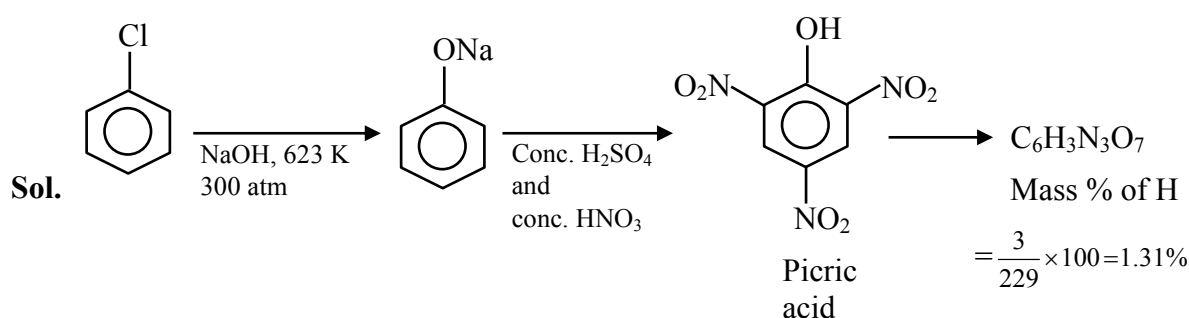

8. If the reaction sequence given below is carried out with 15 moles of acetylene, the amount of the product **D** formed (in g) is \_\_\_\_\_.

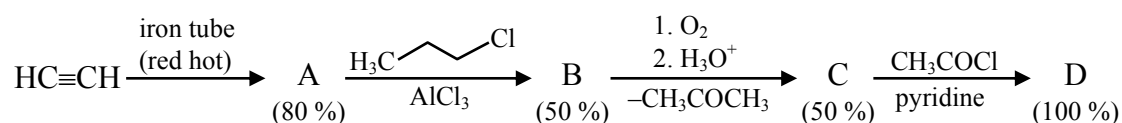

The yields of **A**, **B**, **C** and **D** are given in parentheses.

[Given : Atomic mass of H = 1, C = 12, O = 16, Cl = 35]

Ans. (136)

Sol.

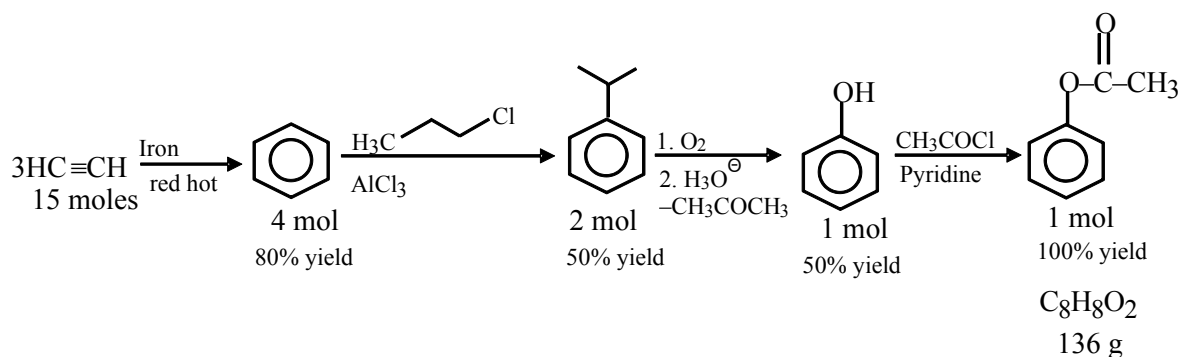

**SECTION-2 : (Maximum Marks : 24)**

- This section contains **SIX (06)** questions.
- Each question has **FOUR** options (A), (B), (C) and (D). **ONE OR MORE THAN ONE** of these four option(s) is (are) correct answer(s).
- For each question, choose the option(s) corresponding to (all) the correct answer(s).
- Answer to each question will be evaluated according to the following marking scheme:

<i>Full Marks</i>	: +4	<b>ONLY</b> if (all) the correct option(s) is(are) chosen;
<i>Partial Marks</i>	: +3	If all the four options are correct but <b>ONLY</b> three options are chosen;
<i>Partial Marks</i>	: +2	If three or more options are correct but <b>ONLY</b> two options are chosen, both of which are correct;
<i>Partial Marks</i>	: +1	If two or more options are correct but <b>ONLY</b> one option is chosen and it is a correct option;
<i>Zero Marks</i>	: 0	If none of the options is chosen (i.e. the question is unanswered);
<i>Negative Marks</i>	: -2	In all other cases.

9. For diatomic molecules, the correct statement(s) about the molecular orbitals formed by the overlap to two  $2p_z$  orbitals is(are)
- (A)  $\sigma$  orbital has a total of two nodal planes.
- (B)  $\sigma^*$  orbital has one node in the  $xz$ -plane containing the molecular axis.
- (C)  $\pi$  orbital has one node in the plane which is perpendicular to the molecular axis and goes through the center of the molecule.
- (D)  $\pi^*$  orbital has one node in the  $xy$ -plane containing the molecular axis.

**Ans. (A,D)**

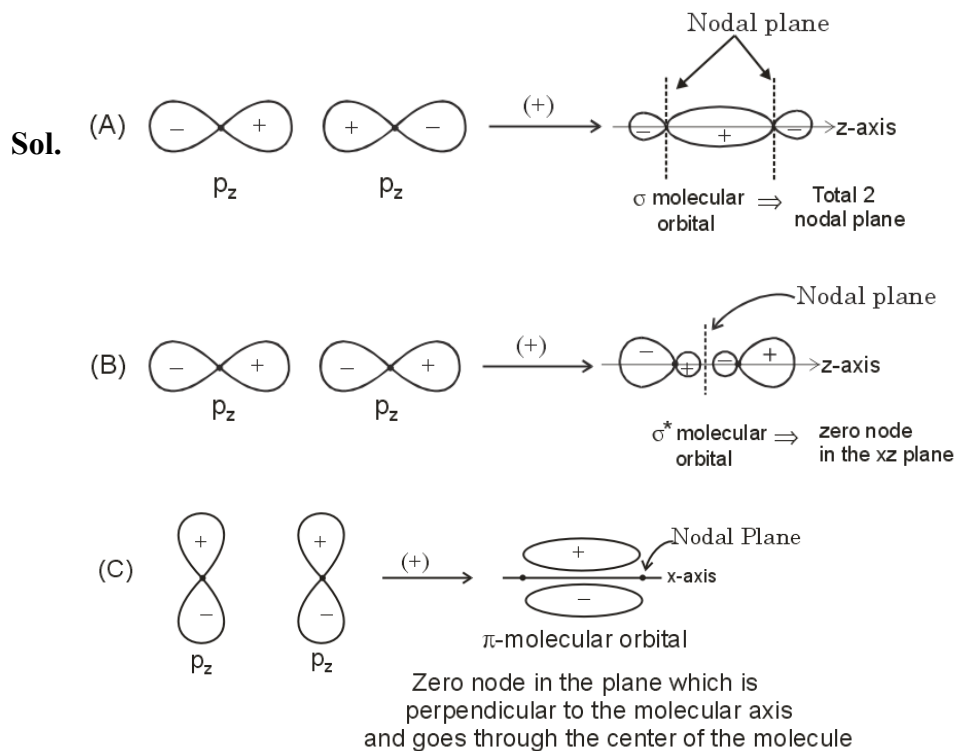

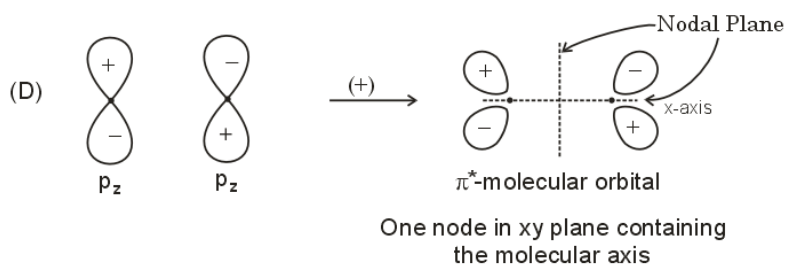

10. The correct option(s) related to adsorption processes is(are)

- (A) Chemisorption results in a unimolecular layer.
- (B) The enthalpy change during physisorption is in the range of 100 to 140 kJ mol<sup>-1</sup>.
- (C) Chemisorption is an endothermic process.
- (D) Lowering the temperature favors physisorption processes.

Ans. (A,D)

Sol. (A) Chemisorption is unimolecular layered.

- (B) Enthalpy of physisorption is much less in magnitude.
- (C) Chemisorption of gases on solids is exothermic.
- (D) As physisorption is exothermic so lowering temperature favours it.

11. The electrochemical extraction of aluminum from bauxite ore involves.

- (A) the reaction of Al<sub>2</sub>O<sub>3</sub> with coke (C) at a temperature > 2500°C.
- (B) the neutralization of aluminate solution by passing CO<sub>2</sub> gas to precipitate hydrated alumina (Al<sub>2</sub>O<sub>3</sub>·3H<sub>2</sub>O)
- (C) the dissolution of Al<sub>2</sub>O<sub>3</sub> in hot aqueous NaOH.
- (D) the electrolysis of Al<sub>2</sub>O<sub>3</sub> mixed with Na<sub>3</sub>AlF<sub>6</sub> to give Al and CO<sub>2</sub>.

Ans. (B,C,D)

Sol. (A) Electrochemical extraction of Aluminum from bauxite done below 2500°C

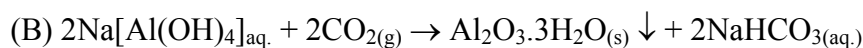

The sodium aluminate present in solution is neutralised by passing CO<sub>2</sub> gas and hydrated Al<sub>2</sub>O<sub>3</sub> is precipitated.

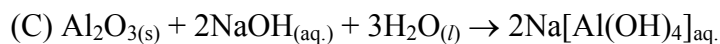

Concentration of bauxite is carried out by heating the powdered ore with hot concentrated solution of NaOH

(D) In metallurgy of aluminum, Al<sub>2</sub>O<sub>3</sub> is mixed with Na<sub>3</sub>AlF<sub>6</sub>



12. The treatment of galena with  $\text{HNO}_3$  produces a gas that is
- (A) paramagnetic (B) bent in geometry  
(C) an acidic oxide (D) colorless

Ans. (A,D)



$\text{NO} \Rightarrow$  Neutral oxide, Paramagnetic, Linear geometry, Colourless gas

13. Considering the reaction sequence given below, the correct statement(s) is(are)

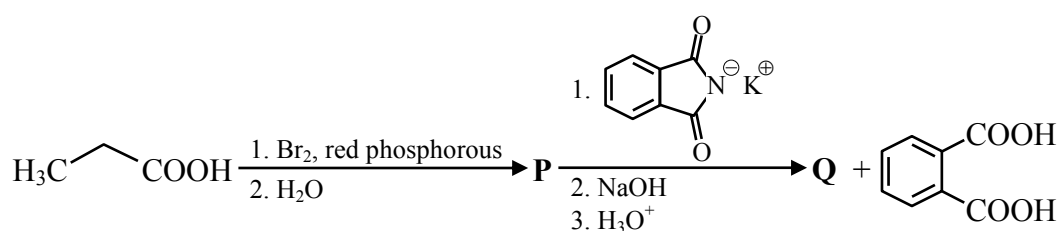

- (A) **P** can be reduced to a primary alcohol using  $\text{NaBH}_4$ .  
 (B) Treating **P** with conc.  $\text{NH}_4\text{OH}$  solution followed by acidification gives **Q**.  
 (C) Treating **Q** with a solution of  $\text{NaNO}_2$  in aq.  $\text{HCl}$  liberates  $\text{N}_2$ .  
 (D) **P** is more acidic than  $\text{CH}_3\text{CH}_2\text{COOH}$ .

Ans. (B,C,D)

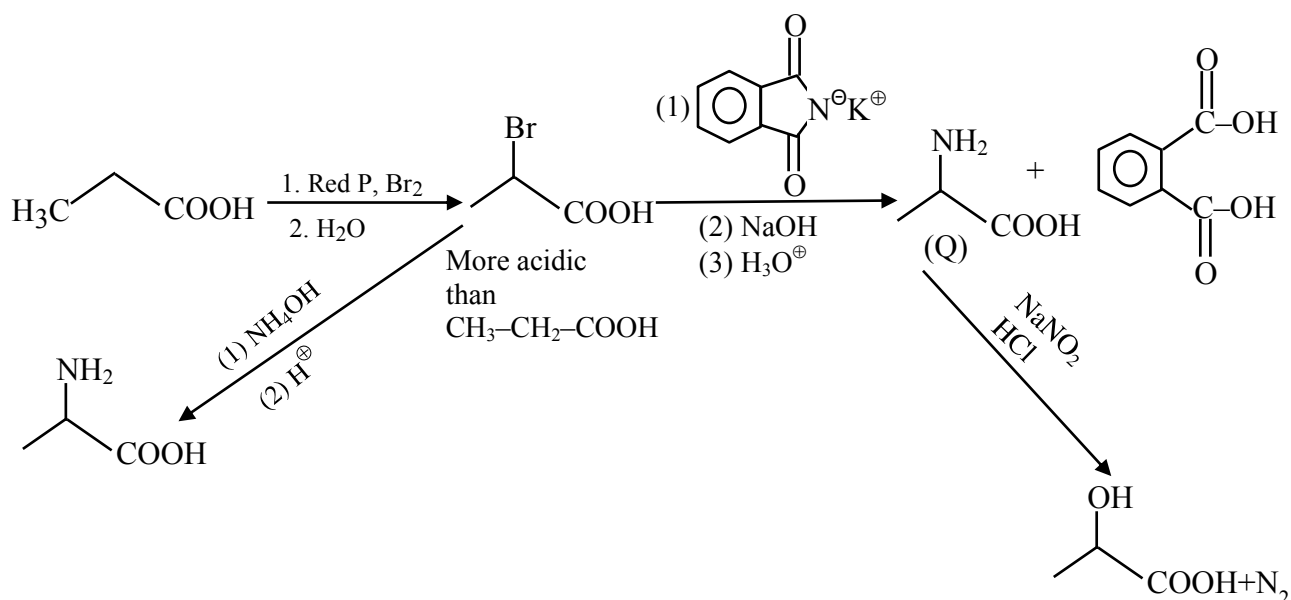

Sol.





14. Consider the following reaction sequence,

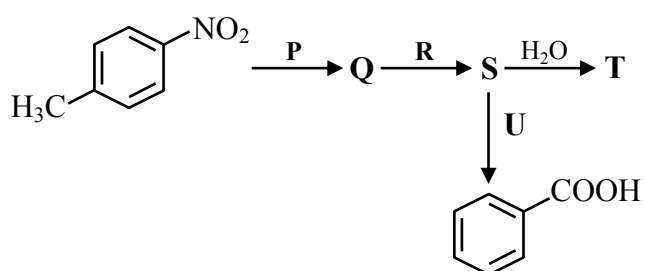

the correct option(s) is(are)

(A) **P** =  $H_2/Pd$ , ethanol

**R** =  $NaNO_2/HCl$

**U** = 1.  $H_3PO_2$

2.  $KMnO_4 - KOH$ , heat

(B) **P** =  $Sn/HCl$

**R** =  $HNO_2$

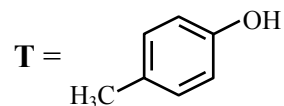
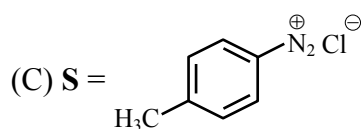
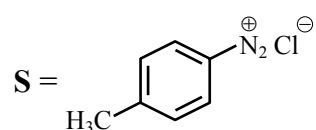

**U** = 1.  $CH_3CH_2OH$

2.  $KMnO_4 - KOH$ , heat

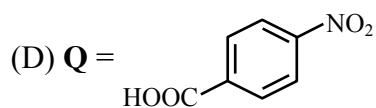

**R** =  $H_2/Pd$ , ethanol

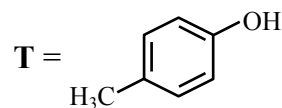

**Ans.** (A,B,C)

**Sol.**

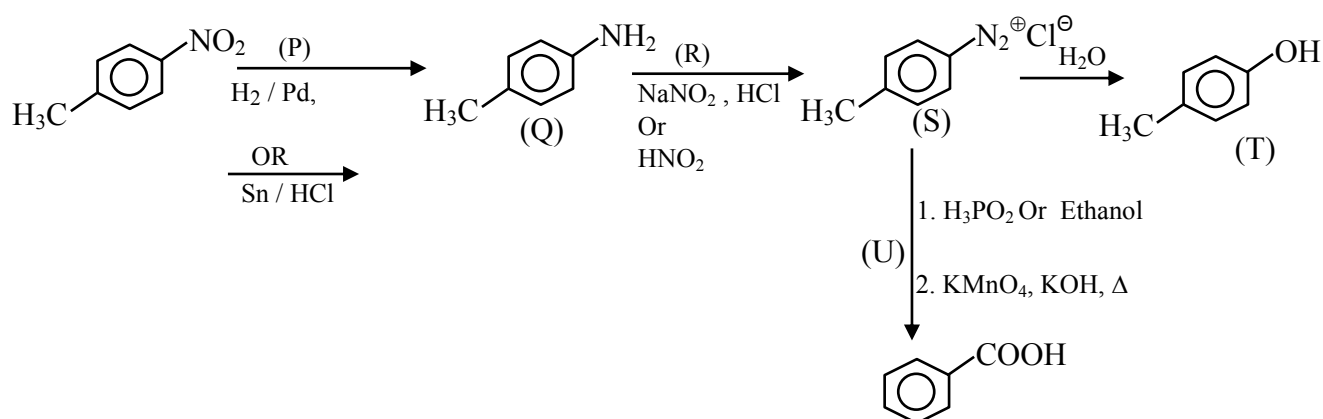

**SECTION-3 : (Maximum Marks : 12)**

- This section contains **FOUR (04)** Matching List Sets.
- Each set has **ONE** Multiple Choice Question.
- Each set has **TWO** lists : **List-I** and **List-II**.
- **List-I** has **Four** entries (I), (II), (III) and (IV) and **List-II** has **Five** entries (P), (Q), (R), (S) and (T).
- **FOUR** options are given in each Multiple Choice Question based on **List-I** and **List-II** and **ONLY ONE** of these four options satisfies the condition asked in the Multiple Choice Question.
- Answer to each question will be evaluated according to the following marking scheme:  
*Full Marks* : +3 **ONLY** if the option corresponding to the correct combination is chosen;  
*Zero Marks* : 0 If none of the options is chosen (i.e. the question is unanswered);  
*Negative Marks* : -1 In all other cases.

15. Match the rate expressions in LIST-I for the decomposition of X with the corresponding profiles provided in LIST-II.  $X_s$  and k constants having appropriate units.

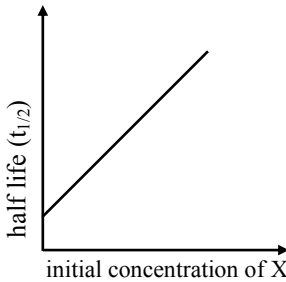
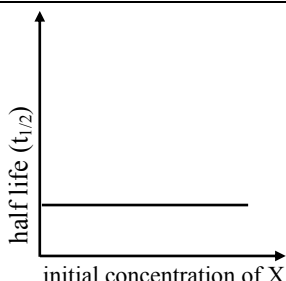
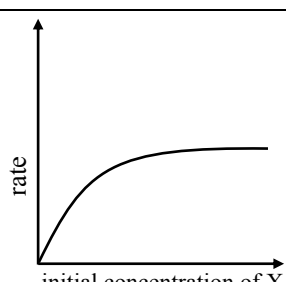
LIST-I	LIST-II
(I) $\text{rate} = \frac{k[X]}{X_s + [X]}$ under all possible initial concentration of X	(P) 
(II) $\text{rate} = \frac{k[X]}{X_s + [X]}$ where initial concentration of X are much less than $X_s$	(Q) 
(III) $\text{rate} = \frac{k[X]}{X_s + [X]}$ where initial concentration of X are much higher than $X_s$	(R) 

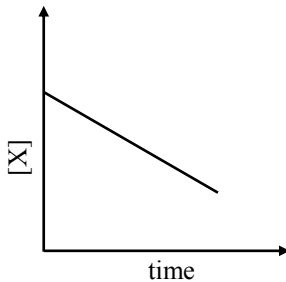
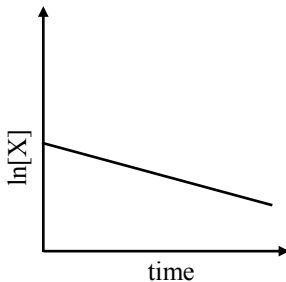

<p>(IV)</p> $\text{rate} = \frac{k[X]^2}{X_s + [X]}$ <p>where initial concentration of X is much higher than <math>X_s</math></p>	<p>(S)</p> 
	<p>(T)</p> 

- (A) I  $\rightarrow$  P; II  $\rightarrow$  Q; III  $\rightarrow$  S; IV  $\rightarrow$  T  
 (B) I  $\rightarrow$  R; II  $\rightarrow$  S; III  $\rightarrow$  S; IV  $\rightarrow$  T  
 (C) I  $\rightarrow$  P; II  $\rightarrow$  Q; III  $\rightarrow$  Q; IV  $\rightarrow$  R  
 (D) I  $\rightarrow$  R; II  $\rightarrow$  S; III  $\rightarrow$  Q; IV  $\rightarrow$  R

**Ans. (A)**

**Sol. (I)** 
$$\text{rate} = \frac{k[x]}{x_s + [x]} = \frac{k}{\frac{x_s}{[x]} + 1}$$

If  $[x] \rightarrow \infty \Rightarrow \text{rate} \rightarrow k \Rightarrow \text{order} = 0$

$\Rightarrow$  (I) – (R), (P)

(II)  $[x] \ll x_s \Rightarrow \text{rate} = \frac{k[x]}{x_s} \Rightarrow \text{order} = 1$

$\Rightarrow$  (II) – (Q), (T)

(III)  $[x] \gg x_s \Rightarrow \text{rate} = k \Rightarrow \text{order} = 0$

$\Rightarrow$  (III) – (P), (S)

(IV) 
$$\text{rate} = \frac{k[x]^2}{x_s + [x]}$$

$[x] \gg x_s \Rightarrow \text{rate} = k[x]$

$\Rightarrow$  (IV) – (Q), (T)

**Ans. (A)**



16. LIST-I contains compounds and LIST-II contains reaction

LIST-I	LIST-II
(I) $\text{H}_2\text{O}_2$	(P) $\text{Mg}(\text{HCO}_3)_2 + \text{Ca}(\text{OH})_2 \rightarrow$
(II) $\text{Mg}(\text{OH})_2$	(Q) $\text{BaO}_2 + \text{H}_2\text{SO}_4 \rightarrow$
(III) $\text{BaCl}_2$	(R) $\text{Ca}(\text{OH})_2 + \text{MgCl}_2$
(IV) $\text{CaCO}_3$	(S) $\text{BaO}_2 + \text{HCl} \rightarrow$
	(T) $\text{Ca}(\text{HCO}_3)_2 + \text{Ca}(\text{OH})_2 \rightarrow$

Match each compound in LIST – I with its formation reaction(s) in LIST-II, and choose the correct option

- (A) I  $\rightarrow$  Q; II  $\rightarrow$  P; III  $\rightarrow$  S; IV  $\rightarrow$  R  
 (B) I  $\rightarrow$  T; II  $\rightarrow$  P; III  $\rightarrow$  Q; IV  $\rightarrow$  R  
 (C) I  $\rightarrow$  T; II  $\rightarrow$  R; III  $\rightarrow$  Q; IV  $\rightarrow$  P  
 (D) I  $\rightarrow$  Q; II  $\rightarrow$  R; III  $\rightarrow$  S; IV  $\rightarrow$  P

Ans. (D)

Sol. (P)  $\text{Mg}(\text{HCO}_3)_2 + 2\text{Ca}(\text{OH})_2 \rightarrow \text{Mg}(\text{OH})_2 + 2\text{CaCO}_3 + 2\text{H}_2\text{O}$

(Q)  $\text{BaO}_2 + \text{H}_2\text{SO}_4 \rightarrow \text{H}_2\text{O}_2 + \text{BaSO}_4$

(R)  $\text{Ca}(\text{OH})_2 + \text{MgCl}_2 \rightarrow \text{Mg}(\text{OH})_2 + \text{CaCl}_2$

(S)  $\text{BaO}_2 + 2\text{HCl} \rightarrow \text{BaCl}_2 + \text{H}_2\text{O}_2$

(T)  $\text{Ca}(\text{HCO}_3)_2 + \text{Ca}(\text{OH})_2 \rightarrow 2\text{CaCO}_3 + 2\text{H}_2\text{O}$

17. LIST-I contains metal species and LIST-II contains their properties.

LIST-I	LIST-II
(I) $[\text{Cr}(\text{CN})_6]^{4-}$	(P) $t_{2g}$ orbitals contain 4 electrons
(II) $[\text{RuCl}_6]^{2-}$	(Q) $\mu(\text{spin-only}) = 4.9 \text{ BM}$
(III) $[\text{Cr}(\text{H}_2\text{O})_6]^{2+}$	(R) low spin complex ion
(IV) $[\text{Fe}(\text{H}_2\text{O})_6]^{2+}$	(S) metal ion in 4+ oxidation state
	(T) $d^4$ species

[Given : Atomic number of Cr = 24, Ru = 44, Fe = 26]

Match each metal species in LIST-I with their properties in LIST-II, and choose the correct option

- (A) I  $\rightarrow$  R, T; II  $\rightarrow$  P, S; III  $\rightarrow$  Q, T; IV  $\rightarrow$  P, Q  
 (B) I  $\rightarrow$  R, S; II  $\rightarrow$  P, T; III  $\rightarrow$  P, Q; IV  $\rightarrow$  Q, T  
 (C) I  $\rightarrow$  P, R; II  $\rightarrow$  R, S; III  $\rightarrow$  R, T; IV  $\rightarrow$  P, T  
 (D) I  $\rightarrow$  Q, T; II  $\rightarrow$  S, T; III  $\rightarrow$  P, T; IV  $\rightarrow$  Q, R

Ans. (A)



Sol. (1)  $[\text{Cr}(\text{CN})_6]^{4-}$

$\text{Cr}^{+2} = [\text{Ar}]_{18} 3d^4 4s^0$  ; low spin complex

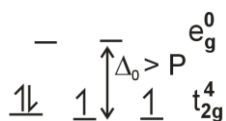

P,R,T

(2)  $[\text{RuCl}_6]^{2-}$

$\text{Ru}^{+4} = [\text{Kr}]_{36} 4d^4 5s^0$  ; low spin complex

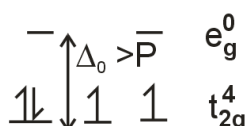

P,R,S,T

(3)  $[\text{Cr}(\text{H}_2\text{O})_6]^{2+}$

$\text{Cr}^{+2} = [\text{Ar}]_{18} 3d^4 4s^0$  ; high spin complex

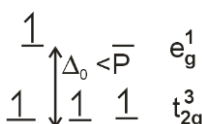

Q,T

(4)  $[\text{Fe}(\text{H}_2\text{O})_6]^{2+}$

$\text{Fe}^{+2} = [\text{Ar}]_{18} 3d^6$  ; High spin complex

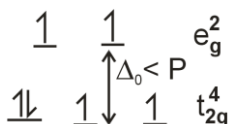

P,Q

18. Match the compounds in LIST-I with the observation in LIST-II, and choose the correct option.

LIST-I

(I) Aniline

(II) o-Cresol

(III) Cysteine

LIST-II

(P) Sodium fusion extract of the compound on boiling with  $\text{FeSO}_4$ , followed by acidification with conc.  $\text{H}_2\text{SO}_4$ , gives Prussian blue color.

(Q) Sodium fusion extract of the compound on treatment with sodium nitroprusside gives blood red color.

(R) Addition of the compound to a saturated solution of  $\text{NaHCO}_3$  results in effervescence.



(IV) Coprolactam

(S) The compound reacts with bromine water to give a white precipitate.

(T) Treating the compound with neutral  $\text{FeCl}_3$  solution produces violet color.

(A) I  $\rightarrow$  P, Q; II  $\rightarrow$  S; III  $\rightarrow$  Q, R; IV  $\rightarrow$  P

(B) I  $\rightarrow$  P ; II  $\rightarrow$  R, S; III  $\rightarrow$  R; IV  $\rightarrow$  Q, S

(C) I  $\rightarrow$  Q, S; II  $\rightarrow$  P, T; III  $\rightarrow$  P; IV  $\rightarrow$  S

(D) I  $\rightarrow$  P, S; II  $\rightarrow$  T; III  $\rightarrow$  Q, R; IV  $\rightarrow$  P

Ans. (D)

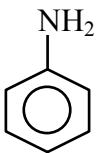
Sol.  : Blue colour in Lassign test due to presence of N  
Aniline

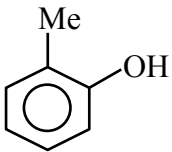
 : Violet colour with  $\text{FeCl}_3$  due to presence of phenolic OH  
o-Cresol

$\text{HS}-\text{CH}_2-\underset{\text{NH}_2}{\text{CH}}-\text{COOH}$   
Cystein : It gives blod red colour with  $\text{NaSCN}$

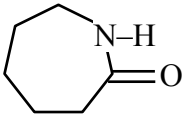
 : Blue colour in Lassign test due to presence of N  
Caprolactam



## MATHEMATICS

### SECTION-1 : (Maximum Marks : 24)

- This section contains **EIGHT (08)** questions.
- The answer to each question is a **NUMERICAL VALUE**.
- For each question, enter the correct numerical value of the answer using the mouse and the on-screen virtual numeric keypad in the place designated to enter the answer. If the numerical value has more than two decimal places, **truncate/round-off** the value to **TWO** decimal places.
- Answer to each question will be evaluated according to the following marking scheme:  
*Full Marks* : +3 **ONLY** if the correct numerical value is entered;  
*Zero Marks* : 0 In all other cases.

1. Considering only the principal values of the inverse trigonometric functions, the value of

$$\frac{3}{2} \cos^{-1} \sqrt{\frac{2}{2+\pi^2}} + \frac{1}{4} \sin^{-1} \frac{2\sqrt{2}\pi}{2+\pi^2} + \tan^{-1} \frac{\sqrt{2}}{\pi}$$

is \_\_\_\_\_.

**Ans. (2.35 or 2.36)**

**Sol.**  $\cos^{-1} \sqrt{\frac{2}{2+\pi^2}} = \tan^{-1} \frac{\pi}{\sqrt{2}}$

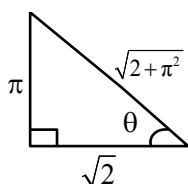

$$\sin^{-1} \left( \frac{2\sqrt{2}\pi}{2+\pi^2} \right) = \sin^{-1} \left( \frac{2 \times \frac{\pi}{\sqrt{2}}}{1 + \left( \frac{\pi}{\sqrt{2}} \right)^2} \right)$$

$$= \pi - 2 \tan^{-1} \left( \frac{\pi}{\sqrt{2}} \right)$$

$$\left( \text{As, } \sin^{-1} \left( \frac{2x}{1+x^2} \right) = \pi - 2 \tan^{-1} x, x \geq 1 \right)$$

$$\text{and } \tan^{-1} \frac{\sqrt{2}}{\pi} = \cot^{-1} \left( \frac{\pi}{\sqrt{2}} \right)$$



$$\begin{aligned}
\therefore \text{Expression} &= \frac{3}{2} \left( \tan^{-1} \frac{\pi}{\sqrt{2}} \right) + \frac{1}{4} \left( \pi - 2 \tan^{-1} \frac{\pi}{\sqrt{2}} \right) + \cot^{-1} \left( \frac{\pi}{\sqrt{2}} \right) \\
&= \left( \frac{3}{2} - \frac{2}{4} \right) \tan^{-1} \frac{\pi}{\sqrt{2}} + \frac{\pi}{4} + \cot^{-1} \frac{\pi}{\sqrt{2}} \\
&= \left( \tan^{-1} \frac{\pi}{\sqrt{2}} + \cot^{-1} \frac{\pi}{\sqrt{2}} \right) + \frac{\pi}{4} \\
&= \frac{\pi}{2} + \frac{\pi}{4} = \frac{3\pi}{4} \\
&= 2.35 \text{ or } 2.36
\end{aligned}$$

2. Let  $\alpha$  be a positive real number. Let  $f: \mathbb{R} \rightarrow \mathbb{R}$  and  $g: (\alpha, \infty) \rightarrow \mathbb{R}$  be the functions defined by

$$f(x) = \sin\left(\frac{\pi x}{12}\right) \text{ and } g(x) = \frac{2 \log_e(\sqrt{x} - \sqrt{\alpha})}{\log_e(e^{\sqrt{x}} - e^{\sqrt{\alpha}})}.$$

Then the value of  $\lim_{x \rightarrow \alpha^+} f(g(x))$  is \_\_\_\_\_.

**Ans. (0.50)**

**Sol.**  $\lim_{x \rightarrow \alpha^+} \frac{2 \ln(\sqrt{x} - \sqrt{\alpha})}{\ln(e^{\sqrt{x}} - e^{\sqrt{\alpha}})} \quad \left( \frac{0}{0} \text{ form} \right)$

$\therefore$  Using Lopital rule,

$$\begin{aligned}
&= 2 \lim_{x \rightarrow \alpha^+} \frac{\left( \frac{1}{\sqrt{x} - \sqrt{\alpha}} \right) \cdot \frac{1}{2\sqrt{x}}}{\left( \frac{1}{e^{\sqrt{x}} - e^{\sqrt{\alpha}}} \right) \cdot e^{\sqrt{x}} \cdot \frac{1}{2\sqrt{x}}} \\
&= \frac{2}{e^{\sqrt{\alpha}}} \lim_{x \rightarrow \alpha^+} \frac{\left( e^{\sqrt{x}} - e^{\sqrt{\alpha}} \right)}{\left( \sqrt{x} - \sqrt{\alpha} \right)} \quad \left( \frac{0}{0} \right) \\
&= \frac{2}{e^{\sqrt{\alpha}}} \lim_{x \rightarrow \alpha^+} \frac{\left( e^{\sqrt{x}} \cdot \frac{1}{2\sqrt{x}} - 0 \right)}{\left( \frac{1}{2\sqrt{x}} - 0 \right)} = 2
\end{aligned}$$

so,  $\lim_{x \rightarrow \alpha^+} f(g(x)) = \lim_{x \rightarrow \alpha^+} f(2)$

$$\begin{aligned}
&= f(2) = \sin \frac{\pi}{6} = \frac{1}{2} \\
&= 0.50
\end{aligned}$$





3. In a study about a pandemic, data of 900 persons was collected. It was found that
- 190 persons had symptom of fever,
  - 220 persons had symptom of cough,
  - 220 persons had symptom of breathing problem,
  - 330 persons had symptom of fever or cough or both,
  - 350 persons had symptom of cough or breathing problem or both,
  - 340 persons had symptom of fever or breathing problem or both,
  - 30 persons had all three symptoms (fever, cough and breathing problem).

If a person is chosen randomly from these 900 persons, then the probability that the person has at most one symptom is \_\_\_\_\_.

**Ans. (0.80)**

**Sol.**  $n(U) = 900$

Let  $A \equiv$  Fever,  $B \equiv$  Cough

$C \equiv$  Breathing problem

$$\therefore n(A) = 190, n(B) = 220, n(C) = 220$$

$$n(A \cup B) = 330, n(B \cup C) = 350,$$

$$n(A \cup C) = 340, n(A \cap B \cap C) = 30$$

$$\text{Now } n(A \cup B) = n(A) + n(B) - n(A \cap B)$$

$$\Rightarrow 330 = 190 + 220 - n(A \cap B)$$

$$\Rightarrow n(A \cap B) = 80$$

Similarly,

$$350 = 220 + 220 - n(B \cap C)$$

$$\Rightarrow n(B \cap C) = 90$$

$$\text{and } 340 = 190 + 220 - n(A \cap C)$$

$$\Rightarrow n(A \cap C) = 70$$

$$\therefore n(A \cup B \cup C) = (190 + 220 + 220) - (80 + 90 + 70) + 30$$

$$= 660 - 240 = 420$$

$$\Rightarrow \text{Number of person without any symptom}$$

$$= n(U) - n(A \cup B \cup C)$$

$$= 900 - 420 = 480$$

Now, number of person suffering from exactly one symptom



$$\begin{aligned}
&= (n(A) + n(B) + n(C)) - 2(n(A \cap B) + n(B \cap C) + n(C \cap A)) + 3n(A \cap B \cap C) \\
&= (190 + 220 + 220) - 2(80 + 90 + 70) + 3(30) \\
&= 630 - 480 + 90 = 240
\end{aligned}$$

$\therefore$  Number of person suffering from atmost one symotom  
 $= 480 + 240 = 720$

$$\Rightarrow \text{Probability} = \frac{720}{900} = \frac{8}{10} = \frac{4}{5} = 0.80$$

4. Let  $z$  be a complex number with non-zero imaginary part. If

$$\frac{2 + 3z + 4z^2}{2 - 3z + 4z^2}$$

is a real number, then the value of  $|z|^2$  is \_\_\_\_\_.

**Ans. (0.50)**

**Sol.** Given that

$$z \neq \bar{z}$$

$$\text{Let } \alpha = \frac{2 + 3z + 4z^2}{2 - 3z + 4z^2} = \frac{(2 - 3z + 4z^2) + 6z}{2 - 3z + 4z^2}$$

$$\therefore \alpha = 1 + \frac{6z}{2 - 3z + 4z^2}$$

If  $\alpha$  is a real number, then

$$\alpha = \bar{\alpha}$$

$$\Rightarrow \frac{z}{2 - 3z + 4z^2} = \frac{\bar{z}}{2 - 3\bar{z} + 4\bar{z}^2}$$

$$\therefore 2(z - \bar{z}) = 4z\bar{z}(z - \bar{z})$$

$$\Rightarrow (z - \bar{z})(2 - 4z\bar{z}) = 0$$

As  $z \neq \bar{z}$  (Given)

$$\Rightarrow z\bar{z} = \frac{2}{4} = \frac{1}{2}$$

$$\Rightarrow |z|^2 = 0.50$$

5. Let  $\bar{z}$  denote the complex conjugate of a complex number  $z$  and let  $i = \sqrt{-1}$ . In the set of complex numbers, the number of distinct roots of the equation

$$\bar{z} - z^2 = i(\bar{z} + z^2)$$

is \_\_\_\_\_.

**Ans. (4.00)**



**Sol.** Given ,

$$\bar{z} - z^2 = i(\bar{z} + z^2)$$

$$\Rightarrow (1-i)\bar{z} = (1+i)z^2$$

$$\Rightarrow \frac{(1-i)}{(1+i)}\bar{z} = z^2$$

$$\Rightarrow \left(-\frac{2i}{2}\right)\bar{z} = z^2$$

$$\therefore z^2 = -i\bar{z}$$

Let  $z = x + iy$ ,

$$\therefore (x^2 - y^2) + i(2xy) = -i(x - iy)$$

$$\text{so, } x^2 - y^2 + y = 0 \quad \dots(1)$$

$$\text{and } (2y + 1)x = 0 \quad \dots(2)$$

$$\Rightarrow x = 0 \text{ or } y = -\frac{1}{2}$$

Case I : When  $x = 0$

$$\therefore (1) \Rightarrow y(1 - y) = 0 \Rightarrow y = 0, 1$$

$$\therefore (0,0), (0,1)$$

Case II : When  $y = -\frac{1}{2}$

$$\therefore (1) \Rightarrow x^2 - \frac{1}{4} - \frac{1}{2} = 0 \Rightarrow x^2 = \frac{3}{4} \Rightarrow x = \pm \frac{\sqrt{3}}{2}$$

$$\therefore \left(\frac{\sqrt{3}}{2}, -\frac{1}{2}\right), \left(-\frac{\sqrt{3}}{2}, -\frac{1}{2}\right)$$

$\Rightarrow$  Number of distinct 'z' is equal to 4.

6. Let  $l_1, l_2, \dots, l_{100}$  be consecutive terms of an arithmetic progression with common difference  $d_1$ , and let  $w_1, w_2, \dots, w_{100}$  be consecutive terms of another arithmetic progression with common difference  $d_2$ , where  $d_1 d_2 = 10$ . For each  $i = 1, 2, \dots, 100$ , let  $R_i$  be a rectangle with length  $l_i$ , width  $w_i$  and area  $A_i$ . If  $A_{51} - A_{50} = 1000$ , then the value of  $A_{100} - A_{90}$  is \_\_\_\_\_.

**Ans. (18900.00)**



**Sol.** Given

$$A_{51} - A_{50} = 1000 \Rightarrow \ell_{51}w_{51} - \ell_{50}w_{50} = 1000$$

$$\Rightarrow (\ell_1 + 50d_1)(w_1 + 50d_2) - (\ell_1 + 49d_1)(w_1 + 49d_2) = 1000$$

$$\Rightarrow (\ell_1d_2 + w_1d_1) = 10 \quad \dots(1)$$

(As  $d_1d_2 = 10$ )

$$\therefore A_{100} - A_{90} = \ell_{100}w_{100} - \ell_{90}w_{90}$$

$$= (\ell_1 + 99d_1)(w_1 + 99d_2) - (\ell_1 + 89d_1)(w_1 + 89d_2)$$

$$= 10(\ell_1d_2 + w_1d_1) + (99^2 - 89^2)d_1d_2$$

$$= 10(10) + \underbrace{(99 - 89)}_{=10}(99 + 89)(10)$$

(As,  $d_1d_2 = 10$ )

$$= 100(1 + 188) = 100(189)$$

$$= 18900$$

7. The number of 4-digit integers in the closed interval [2022, 4482] formed by using the digits 0, 2, 3, 4, 6, 7 is \_\_\_\_\_.

**Ans. (569.00)**

**Sol. Ans. 569**

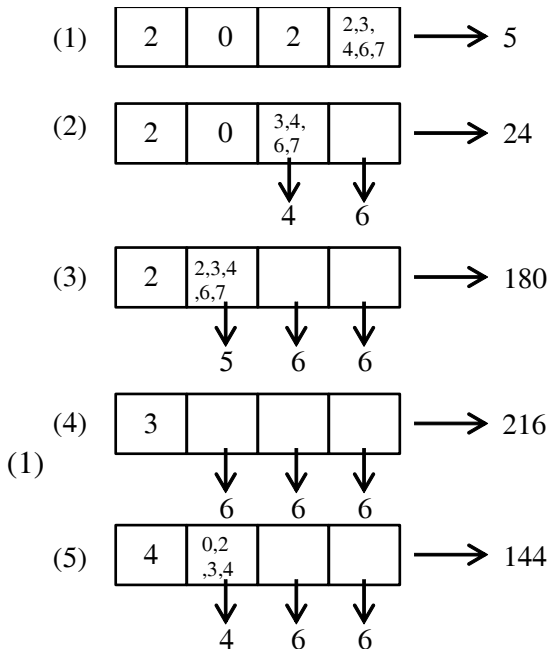

Number of 4 digit integers in [2022,4482]

$$= 5 + 24 + 180 + 216 + 144 = 569$$



8. Let  $ABC$  be the triangle with  $AB = 1$ ,  $AC = 3$  and  $\angle BAC = \frac{\pi}{2}$ . If a circle of radius  $r > 0$  touches the sides  $AB$ ,  $AC$  and also touches internally the circumcircle of the triangle  $ABC$ , then the value of  $r$  is \_\_\_\_\_.

**Ans. (0.83 or 0.84)**

**Sol.**  $4 - \sqrt{10} = 0.83$  or  $0.84$

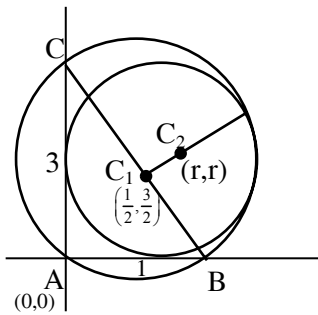

$$C_1 \left( \frac{1}{2}, \frac{3}{2} \right) \text{ and } r_1 = \frac{\sqrt{10}}{2}$$

$$C_2 = (r, r)$$

$\therefore$  circle  $C_2$  touches  $C_1$  internally

$$\Rightarrow C_1 C_2 = \left| r - \frac{\sqrt{10}}{2} \right|$$

$$\Rightarrow \left( r - \frac{1}{2} \right)^2 + \left( r - \frac{3}{2} \right)^2 = \left( r - \frac{\sqrt{10}}{2} \right)^2$$

$$r^2 - 4r + \sqrt{10}r = 0$$

$$r = 0 \text{ (reject) or } r = 4 - \sqrt{10}$$



**SECTION-2 : (Maximum Marks : 24)**

- This section contains **SIX (06)** questions.
  - Each question has **FOUR** options (A), (B), (C) and (D). **ONE OR MORE THAN ONE** of these four option(s) is (are) correct answer(s).
  - For each question, choose the option(s) corresponding to (all) the correct answer(s).
  - Answer to each question will be evaluated according to the following marking scheme:
 

<i>Full Marks</i>	: +4	<b>ONLY</b> if (all) the correct option(s) is(are) chosen;
<i>Partial Marks</i>	: +3	If all the four options are correct but <b>ONLY</b> three options are chosen;
<i>Partial Marks</i>	: +2	If three or more options are correct but <b>ONLY</b> two options are chosen, both of which are correct;
<i>Partial Marks</i>	: +1	If two or more options are correct but <b>ONLY</b> one option is chosen and it is a correct option;
<i>Zero Marks</i>	: 0	If none of the options is chosen (i.e. the question is unanswered);
<i>Negative Marks</i>	: -2	In all other cases.
- 

9. Consider the equation

$$\int_1^e \frac{(\log_e x)^{1/2}}{x(a - (\log_e x)^{3/2})^2} dx = 1, \quad a \in (-\infty, 0) \cup (1, \infty).$$

Which of the following statements is/are TRUE ?

- (A) **No**  $a$  satisfies the above equation
- (B) An integer  $a$  satisfies the above equation
- (C) An irrational number  $a$  satisfies the above equation
- (D) More than one  $a$  satisfy the above equation

**Ans. (C, D)**

**Sol.** 
$$\int_1^e \frac{(\log_e x)^{1/2}}{x(a - (\log_e x)^{3/2})^2} dx = 1$$

Let  $a - (\log_e x)^{3/2} = t$

$$\frac{(\log_e x)^{1/2}}{x} dx = -\frac{2}{3} dt$$

$$= \frac{2}{3} \int_a^{a-1} \frac{-dt}{t^2} = \frac{2}{3} \left( \frac{1}{t} \right)_a^{a-1} = 1$$

$$\frac{2}{3a(a-1)} = 1$$

$$3a^2 - 3a - 2 = 0$$

$$a = \frac{3 \pm \sqrt{33}}{6}$$



10. Let  $a_1, a_2, a_3, \dots$  be an arithmetic progression with  $a_1 = 7$  and common difference 8. Let  $T_1, T_2, T_3, \dots$  be such that  $T_1 = 3$  and  $T_{n+1} - T_n = a_n$  for  $n \geq 1$ . Then, which of the following is/are TRUE ?

(A)  $T_{20} = 1604$

(B)  $\sum_{k=1}^{20} T_k = 10510$

(C)  $T_{30} = 3454$

(D)  $\sum_{k=1}^{30} T_k = 35610$

**Ans. (B,C)**

**Sol.**  $a_1 = 7, d = 8$

$$T_{n+1} - T_n = a_n \forall n \geq 1$$

$$S_n = T_1 + T_2 + T_3 + \dots + T_{n-1} + T_n$$

$$S_n = T_1 + T_2 + T_3 + \dots + T_{n-1} + T_n$$

on subtraction

$$T_n = T_1 + a_1 + a_2 + \dots + a_{n-1}$$

$$T_n = 3 + (n-1)(8)$$

$$T_n = 4n^2 - 5n + 4$$

$$\sum_{k=1}^n T_k = 4 \sum_{k=1}^n k^2 - 5 \sum_{k=1}^n k + 4n$$

$$T_{20} = 1504$$

$$T_{30} = 3454$$

$$\sum_{k=1}^{30} T_k = 35615$$

$$\sum_{k=1}^{20} T_k = 10510$$



11. Let  $P_1$  and  $P_2$  be two planes given by

$$P_1: 10x + 15y + 12z - 60 = 0,$$

$$P_2: -2x + 5y + 4z - 20 = 0.$$

Which of the following straight lines can be an edge of some tetrahedron whose two faces lie on  $P_1$  and  $P_2$  ?

(A)  $\frac{x-1}{0} = \frac{y-1}{0} = \frac{z-1}{5}$

(B)  $\frac{x-6}{-5} = \frac{y}{2} = \frac{z}{3}$

(C)  $\frac{x}{-2} = \frac{y-4}{5} = \frac{z}{4}$

(D)  $\frac{x}{1} = \frac{y-4}{-2} = \frac{z}{3}$

Ans. (A,B,D)

Sol. line of intersection is  $\frac{x}{0} = \frac{y-4}{-4} = \frac{z}{5}$

(1) Any skew line with the line of intersection of given planes can be edge of tetrahedron.

(2) any intersecting line with line of intersection of given planes must lie either in plane  $P_1$  or  $P_2$  can be edge of tetrahedron.

12. Let  $S$  be the reflection of a point  $Q$  with respect to the plane given by

$$\vec{r} = -(t+p)\hat{i} + t\hat{j} + (1+p)\hat{k}$$

where  $t, p$  are real parameters and  $\hat{i}, \hat{j}, \hat{k}$  are the unit vectors along the three positive coordinate axes. If the position vectors of  $Q$  and  $S$  are  $10\hat{i} + 15\hat{j} + 20\hat{k}$  and  $\alpha\hat{i} + \beta\hat{j} + \gamma\hat{k}$  respectively, then which of the following is/are TRUE ?

(A)  $3(\alpha + \beta) = -101$

(B)  $3(\beta + \gamma) = -71$

(C)  $3(\gamma + \alpha) = -86$

(D)  $3(\alpha + \beta + \gamma) = -121$

Ans. (A,B,C)





**Sol.**  $\vec{r} = \hat{k} + t(-\hat{i} + \hat{j}) + p(-\hat{i} + \hat{k})$

$$\vec{n} = \hat{i} + \hat{j} + \hat{k}$$

$$\Rightarrow x + y + z = 1$$

Q(10,15,20) and S( $\alpha, \beta, \gamma$ )

$$\frac{\alpha - 10}{1} = \frac{\beta - 15}{1} = \frac{\gamma - 20}{1} = -2 \left( \frac{10 + 15 + 20 - 1}{1 + 1 + 1} \right)$$

$$= -\frac{88}{3}$$

$$\Rightarrow (\alpha, \beta, \gamma) \equiv \left( -\frac{58}{3}, -\frac{43}{3}, -\frac{28}{3} \right)$$

$\Rightarrow$  A,B,C are correct options

- 13.** Consider the parabola  $y^2 = 4x$ . Let  $S$  be the focus of the parabola. A pair of tangents drawn to the parabola from the point  $P = (-2, 1)$  meet the parabola at  $P_1$  and  $P_2$ . Let  $Q_1$  and  $Q_2$  be points on the lines  $SP_1$  and  $SP_2$  respectively such that  $PQ_1$  is perpendicular to  $SP_1$  and  $PQ_2$  is perpendicular to  $SP_2$ . Then, which of the following is/are TRUE ?

(A)  $SQ_1 = 2$

(B)  $Q_1Q_2 = \frac{3\sqrt{10}}{5}$

(C)  $PQ_1 = 3$

(D)  $SQ_2 = 1$

**Ans. (B,C,D)**

**Sol.** Let equation of tangent with slope 'm' be

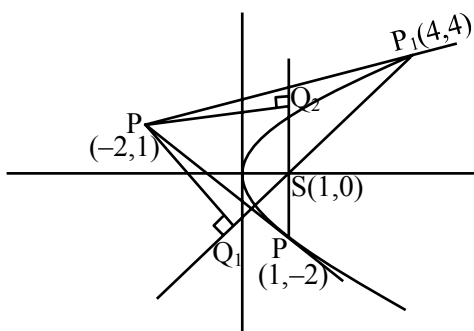

$$T : y = mx + \frac{1}{m}$$

T : passes through  $(-2, 1)$  so

$$1 = -2m + \frac{1}{m}$$



$$\Rightarrow m = -1 \text{ or } m = \frac{1}{2}$$

Points are given by  $\left(\frac{a}{m^2}, \frac{2a}{m}\right)$

So, one point will be (1, -2) & (4, 4)

Let  $P_1(4, 4)$  &  $P_2(1, -2)$

$$P_1S : 4x - 3y - 4 = 0$$

$$P_2S : x - 1 = 0$$

$$PQ_1 = \left| \frac{4(-2) - 3(1) - 4}{5} \right| = 3$$

$$SP = \sqrt{10} ; PQ_2 = 3 ; SQ_1 = 1 = SQ_2$$

$$\frac{1}{2} \left( \frac{Q_1 Q_2}{2} \right) \times \sqrt{10} = \frac{1}{2} \times 3 \times 1 \quad (\text{comparing Areas})$$

$$\Rightarrow Q_1 Q_2 = \frac{2 \times 3}{\sqrt{10}} = \frac{3\sqrt{10}}{5}$$

14. Let  $|M|$  denote the determinant of a square matrix  $M$ . Let  $g : \left[0, \frac{\pi}{2}\right] \rightarrow \mathbb{R}$  be the function defined by

$$g(\theta) = \sqrt{f(\theta) - 1} + \sqrt{f\left(\frac{\pi}{2} - \theta\right) - 1}$$

where

$$f(\theta) = \frac{1}{2} \begin{vmatrix} 1 & \sin \theta & 1 \\ -\sin \theta & 1 & \sin \theta \\ -1 & -\sin \theta & 1 \end{vmatrix} + \begin{vmatrix} \sin \pi & \cos\left(\theta + \frac{\pi}{4}\right) & \tan\left(\theta - \frac{\pi}{4}\right) \\ \sin\left(\theta - \frac{\pi}{4}\right) & -\cos \frac{\pi}{2} & \log_e\left(\frac{4}{\pi}\right) \\ \cot\left(\theta + \frac{\pi}{4}\right) & \log_e\left(\frac{\pi}{4}\right) & \tan \pi \end{vmatrix}.$$

Let  $p(x)$  be a quadratic polynomial whose roots are the maximum and minimum values of the function  $g(\theta)$ , and  $p(2) = 2 - \sqrt{2}$ . Then, which of the following is/are TRUE ?

(A)  $p\left(\frac{3 + \sqrt{2}}{4}\right) < 0$

(B)  $p\left(\frac{1 + 3\sqrt{2}}{4}\right) > 0$

(C)  $p\left(\frac{5\sqrt{2} - 1}{4}\right) > 0$

(D)  $p\left(\frac{5 - \sqrt{2}}{4}\right) < 0$

Ans. (A,C)



$$\text{Sol. } f(\theta) = \frac{1}{2} \begin{vmatrix} 1 & \sin \theta & 1 \\ -\sin \theta & 1 & \sin \theta \\ -1 & -\sin \theta & 1 \end{vmatrix} + \begin{vmatrix} \sin \pi & \cos\left(\theta + \frac{\pi}{4}\right) & \tan\left(\theta - \frac{\pi}{4}\right) \\ \sin\left(\theta - \frac{\pi}{4}\right) & -\cos \frac{\pi}{2} & \log_e\left(\frac{4}{\pi}\right) \\ \cot\left(\theta + \frac{\pi}{4}\right) & \log_e \frac{\pi}{4} & \tan \pi \end{vmatrix}$$

$$f(\theta) = \frac{1}{2} \begin{vmatrix} 2 & \sin \theta & 1 \\ 0 & 1 & \sin \theta \\ 0 & -\sin \theta & 1 \end{vmatrix} + \begin{vmatrix} 0 & -\sin\left(\theta - \frac{\pi}{4}\right) & \tan\left(\theta - \frac{\pi}{4}\right) \\ \sin\left(\theta - \frac{\pi}{4}\right) & 0 & \log_e\left(\frac{4}{\pi}\right) \\ -\tan\left(\theta - \frac{\pi}{4}\right) & -\log_e\left(\frac{4}{\pi}\right) & 0 \end{vmatrix}$$

$$f(\theta) = (1 + \sin^2\theta) + 0 \text{ (skew symmetric)}$$

$$g(\theta) = \sqrt{f(\theta) - 1} + \sqrt{f\left(\frac{\pi}{2} - \theta\right) - 1}$$

$$= |\sin\theta| + |\cos\theta| \quad \text{for } \theta \in \left[0, \frac{\pi}{2}\right]$$

$$g(\theta) \in [1, \sqrt{2}]$$

$$\text{Again let } P(x) = k(x - \sqrt{2})(x - 1)$$

$$2 - \sqrt{2} = k(2 - \sqrt{2})(2 - 1)$$

$$\Rightarrow k = 1 \quad (P(2) = 2 - \sqrt{2} \text{ given})$$

$$\therefore P(x) = (x - \sqrt{2})(x - 1)$$

$$\text{for option (A) } P\left(\frac{3 + \sqrt{2}}{4}\right) < 0 \text{ correct}$$

$$\text{option (B) } P\left(\frac{1 + 3\sqrt{2}}{4}\right) < 0 \text{ incorrect}$$

$$\text{option (C) } P\left(\frac{5\sqrt{2} - 1}{4}\right) > 0 \text{ correct}$$

$$\text{option (D) } P\left(\frac{5 - \sqrt{2}}{4}\right) > 0 \text{ incorrect}$$



**SECTION-3 : (Maximum Marks : 12)**

- This section contains **FOUR (04)** Matching List Sets.
- Each set has **ONE** Multiple Choice Question.
- Each set has **TWO** lists : **List-I** and **List-II**.
- **List-I** has **Four** entries (I), (II), (III) and (IV) and **List-II** has **Five** entries (P), (Q), (R), (S) and (T).
- **FOUR** options are given in each Multiple Choice Question based on **List-I** and **List-II** and **ONLY ONE** of these four options satisfies the condition asked in the Multiple Choice Question.
- Answer to each question will be evaluated according to the following marking scheme:  
*Full Marks* : +3 **ONLY** if the option corresponding to the correct combination is chosen;  
*Zero Marks* : 0 If none of the options is chosen (i.e. the question is unanswered);  
*Negative Marks* : -1 In all other cases.

15. Consider the following lists:

List-I		List-II	
(I)	$\left\{ x \in \left[ -\frac{2\pi}{3}, \frac{2\pi}{3} \right] : \cos x + \sin x = 1 \right\}$	(P)	has two elements
(II)	$\left\{ x \in \left[ -\frac{5\pi}{18}, \frac{5\pi}{18} \right] : \sqrt{3} \tan 3x = 1 \right\}$	(Q)	has three elements
(III)	$\left\{ x \in \left[ -\frac{6\pi}{5}, \frac{6\pi}{5} \right] : 2 \cos(2x) = \sqrt{3} \right\}$	(R)	has four elements
(IV)	$\left\{ x \in \left[ -\frac{7\pi}{4}, \frac{7\pi}{4} \right] : \sin x - \cos x = 1 \right\}$	(S)	has five elements
		(T)	has six elements

The correct option is:

- (A) (I) → (P); (II) → (S); (III) → (P); (IV) → (S)  
 (B) (I) → (P); (II) → (P); (III) → (T); (IV) → (R)  
 (C) (I) → (Q); (II) → (P); (III) → (T); (IV) → (S)  
 (D) (I) → (Q); (II) → (S); (III) → (P); (IV) → (R)

**Ans. (B)**

**Sol. (I)**  $\left\{ x \in \left[ -\frac{2\pi}{3}, \frac{2\pi}{3} \right] : \cos x + \sin x = 1 \right\}$

$\cos x + \sin x = 1$



$$\Rightarrow \frac{1}{\sqrt{2}} \cos x + \frac{1}{\sqrt{2}} \sin x = \frac{1}{\sqrt{2}}$$

$$\Rightarrow \cos\left(x - \frac{\pi}{4}\right) = \cos \frac{\pi}{4}$$

$$\Rightarrow x - \frac{\pi}{4} = 2n\pi \pm \frac{\pi}{4}; n \in Z$$

$$\Rightarrow x = 2n\pi; x = 2n\pi + \frac{\pi}{2}; n \in Z$$

$\Rightarrow x \in \left\{0, \frac{\pi}{2}\right\}$  in given range has two solutions

$$\text{(II)} \left\{ x \in \left[ \frac{-5\pi}{18}, \frac{5\pi}{18} \right] : \sqrt{3} \tan 3x = 1 \right\}$$

$$\sqrt{3} \tan 3x = 1 \Rightarrow \tan 3x = \frac{1}{\sqrt{3}} \Rightarrow 3x = n\pi + \frac{\pi}{6}$$

$$\Rightarrow x = (6n+1) \frac{\pi}{18}; n \in Z$$

$\Rightarrow x \in \left\{ \frac{\pi}{18}, \frac{-5\pi}{18} \right\}$  in given range has two solutions

$$\text{(III)} \left\{ x \in \left[ -\frac{6\pi}{5}, \frac{6\pi}{5} \right] : 2 \cos(2x) = \sqrt{3} \right\}$$

$$2 \cos 2x = \sqrt{3}$$

$$\Rightarrow \cos 2x = \frac{\sqrt{3}}{2} = \cos \frac{\pi}{6}$$

$$\Rightarrow 2x = 2n\pi \pm \frac{\pi}{6}; n \in Z$$

$$\Rightarrow x = n\pi \pm \frac{\pi}{12}; n \in Z$$

$$x \in \left\{ \pm \frac{\pi}{12}, \pi \pm \frac{\pi}{12}, -\pi \pm \frac{\pi}{12} \right\}$$

Six solutions in given range

$$\text{(IV)} \left\{ x \in \left[ -\frac{7\pi}{4}, \frac{7\pi}{4} \right] : \sin x - \cos x = 1 \right\}$$

$$\cos x - \sin x = -1$$

$$\Rightarrow \cos\left(x + \frac{\pi}{4}\right) = \frac{-1}{\sqrt{2}} = \cos \frac{3\pi}{4}$$

$$\Rightarrow x + \frac{\pi}{4} = 2n\pi \pm \frac{3\pi}{4}; n \in Z$$

$$\Rightarrow x = 2n\pi + \frac{\pi}{2} \text{ or } x = 2n\pi - \pi; n \in Z$$

$\Rightarrow x \in \left\{ \frac{\pi}{2}, \frac{-3\pi}{2}, \pi, -\pi \right\}$  four solutions in given range



16. Two players,  $P_1$  and  $P_2$ , play a game against each other. In every round of the game, each player rolls a fair die once, where the six faces of the die have six distinct numbers. Let  $x$  and  $y$  denote the readings on the die rolled by  $P_1$  and  $P_2$ , respectively. If  $x > y$ , then  $P_1$  scores 5 points and  $P_2$  scores 0 point. If  $x = y$ , then each player scores 2 points. If  $x < y$ , then  $P_1$  scores 0 point and  $P_2$  scores 5 points. Let  $X_i$  and  $Y_i$  be the total scores of  $P_1$  and  $P_2$ , respectively, after playing the  $i^{\text{th}}$  round.

List-I		List-II	
(I)	Probability of $(X_2 \geq Y_2)$ is	(P)	$\frac{3}{8}$
(II)	Probability of $(X_2 > Y_2)$ is	(Q)	$\frac{11}{16}$
(III)	Probability of $(X_3 = Y_3)$ is	(R)	$\frac{5}{16}$
(IV)	Probability of $(X_3 > Y_3)$ is	(S)	$\frac{355}{864}$
		(T)	$\frac{77}{432}$

The correct option is:

- (A) (I)  $\rightarrow$  (Q); (II)  $\rightarrow$  (R); (III)  $\rightarrow$  (T); (IV)  $\rightarrow$  (S)  
 (B) (I)  $\rightarrow$  (Q); (II)  $\rightarrow$  (R); (III)  $\rightarrow$  (T); (IV)  $\rightarrow$  (T)  
 (C) (I)  $\rightarrow$  (P); (II)  $\rightarrow$  (R); (III)  $\rightarrow$  (Q); (IV)  $\rightarrow$  (S)  
 (D) (I)  $\rightarrow$  (P); (II)  $\rightarrow$  (R); (III)  $\rightarrow$  (Q); (IV)  $\rightarrow$  (T)

**Ans. (A)**

**Sol.**  $P(\text{draw in 1 round}) = \frac{6}{36} = \frac{1}{6}$

$$P(\text{win in 1 round}) = \frac{1}{2} \left( 1 - \frac{1}{6} \right) = \frac{5}{12}$$

$$P(\text{loss in 1 round}) = \frac{5}{12}$$

$$P(X_2 > Y_2) = P(10,0) + P(7,2) = \frac{5}{12} \times \frac{5}{12} + \frac{5}{12} \times \frac{1}{6} \times 2 = \frac{45}{144} = \frac{5}{16}$$

$$P(X_2 = Y_2) = P(5,5) + P(4,4) = \frac{5}{12} \times \frac{5}{12} \times 2 + \frac{1}{6} \times \frac{1}{6} = \frac{25+2}{72} = \frac{3}{8}$$

$$P(X_3 = Y_3) = P(6,6) + P(7,7) = \frac{1}{6 \times 6 \times 6} + \frac{5}{12} \times \frac{1}{6} \times \frac{5}{12} \times 6 = \frac{2}{432} + \frac{75}{432} = \frac{77}{432}$$

$$P(X_3 > Y_3) = \frac{1}{2} \left( 1 - \frac{77}{432} \right) = \frac{355}{864}$$



17. Let  $p, q, r$  be nonzero real numbers that are, respectively, the  $10^{\text{th}}, 100^{\text{th}}$  and  $1000^{\text{th}}$  terms of a harmonic progression. Consider the system of linear equations

$$\begin{aligned}x + y + z &= 1 \\10x + 100y + 1000z &= 0 \\qr x + pr y + pq z &= 0.\end{aligned}$$

List-I		List-II	
(I)	If $\frac{q}{r} = 10$ , then the system of linear equations has	(P)	$x = 0, y = \frac{10}{9}, z = -\frac{1}{9}$ as a solution
(II)	If $\frac{p}{r} \neq 100$ , then the system of linear equations has	(Q)	$x = \frac{10}{9}, y = -\frac{1}{9}, z = 0$ as a solution
(III)	If $\frac{p}{q} \neq 10$ , then the system of linear equations has	(R)	infinitely many solutions
(IV)	If $\frac{p}{q} = 10$ , then the system of linear equations has	(S)	no solution
		(T)	at least one solution

The correct option is:

- (A) (I)  $\rightarrow$  (T); (II)  $\rightarrow$  (R); (III)  $\rightarrow$  (S); (IV)  $\rightarrow$  (T)  
 (B) (I)  $\rightarrow$  (Q); (II)  $\rightarrow$  (S); (III)  $\rightarrow$  (S); (IV)  $\rightarrow$  (R)  
 (C) (I)  $\rightarrow$  (Q); (II)  $\rightarrow$  (R); (III)  $\rightarrow$  (P); (IV)  $\rightarrow$  (R)  
 (D) (I)  $\rightarrow$  (T); (II)  $\rightarrow$  (S); (III)  $\rightarrow$  (P); (IV)  $\rightarrow$  (T)

**Ans. (B)**

**Sol.** If  $\frac{q}{r} = 10 \Rightarrow A = D \Rightarrow D_x = D_y = D_z = 0$

So, there are infinitely many solutions

Look of infinitely many solutions can be given as

$$x + y + z = 1$$

$$\& 10x + 100y + 1000z = 0 \Rightarrow x + 10y + 100z = 0$$



Let  $z = \lambda$

then  $x + y = 1 - \lambda$

and  $x + 10y = -100\lambda$

$$\Rightarrow x = \frac{10}{9} + 10\lambda ; y = \frac{-1}{9} - 11\lambda$$

$$\text{i.e., } (x, y, z) \equiv \left( \frac{10}{9} + 10\lambda, \frac{-1}{9} - 11\lambda, \lambda \right)$$

$$Q\left(\frac{10}{9}, \frac{-1}{9}, 0\right) \text{ valid for } \lambda = 0$$

$$P\left(0, \frac{10}{9}, \frac{-1}{9}\right) \text{ not valid for any } \lambda.$$

(I)  $\rightarrow$  Q,R,T

(II) If  $\frac{p}{r} \neq 100$ , then  $D_y \neq 0$

So no solution

(II)  $\rightarrow$  (S)

(III) If  $\frac{p}{q} \neq 10$ , then  $D_z \neq 0$  so, no solution

(III)  $\rightarrow$  (S)

(IV) If  $\frac{p}{q} = 10 \Rightarrow D_z = 0 \Rightarrow D_x = D_y = 0$

so infinitely many solution

(IV)  $\rightarrow$  Q,R,T





18. Consider the ellipse

$$\frac{x^2}{4} + \frac{y^2}{3} = 1.$$

Let  $H(\alpha, 0)$ ,  $0 < \alpha < 2$ , be a point. A straight line drawn through  $H$  parallel to the  $y$ -axis crosses the ellipse and its auxiliary circle at points  $E$  and  $F$  respectively, in the first quadrant. The tangent to the ellipse at the point  $E$  intersects the positive  $x$ -axis at a point  $G$ . Suppose the straight line joining  $F$  and the origin makes an angle  $\phi$  with the positive  $x$ -axis.

List-I		List-II	
(I)	If $\phi = \frac{\pi}{4}$ , then the area of the triangle $FGH$ is	(P)	$\frac{(\sqrt{3}-1)^4}{8}$
(II)	If $\phi = \frac{\pi}{3}$ , then the area of the triangle $FGH$ is	(Q)	1
(III)	If $\phi = \frac{\pi}{6}$ , then the area of the triangle $FGH$ is	(R)	$\frac{3}{4}$
(IV)	If $\phi = \frac{\pi}{12}$ , then the area of the triangle $FGH$ is	(S)	$\frac{1}{2\sqrt{3}}$
		(T)	$\frac{3\sqrt{3}}{2}$

The correct option is:

- (A) (I)  $\rightarrow$  (R); (II)  $\rightarrow$  (S); (III)  $\rightarrow$  (Q); (IV)  $\rightarrow$  (P)  
 (B) (I)  $\rightarrow$  (R); (II)  $\rightarrow$  (T); (III)  $\rightarrow$  (S); (IV)  $\rightarrow$  (P)  
 (C) (I)  $\rightarrow$  (Q); (II)  $\rightarrow$  (T); (III)  $\rightarrow$  (S); (IV)  $\rightarrow$  (P)  
 (D) (I)  $\rightarrow$  (Q); (II)  $\rightarrow$  (S); (III)  $\rightarrow$  (Q); (IV)  $\rightarrow$  (P)



**Ans. (C)**

**Sol.** Let  $F(2\cos\phi, 2\sin\phi)$

&  $E(2\cos\phi, \sqrt{3}\sin\phi)$

$$EG : \frac{x}{2}\cos\phi + \frac{y}{\sqrt{3}}\sin\phi = 1$$

$$\therefore G\left(\frac{2}{\cos\phi}, 0\right) \text{ and } \alpha = 2\cos\phi$$

$$\text{ar}(\triangle FGH) = \frac{1}{2} HG \times FH$$

$$= \frac{1}{2} \left( \frac{2}{\cos\phi} - 2\cos\phi \right) \times 2\sin\phi$$

$$f(\phi) = 2\tan\phi\sin^2\phi$$

$$\therefore \text{(I) } f\left(\frac{\pi}{4}\right) = 1 \quad \text{(II) } f\left(\frac{\pi}{3}\right) = \frac{3\sqrt{3}}{2} \quad \text{(III) } f\left(\frac{\pi}{6}\right) = \frac{1}{2\sqrt{3}}$$

$$\text{(IV) } f\left(\frac{\pi}{12}\right) = 2(2-\sqrt{3})\left(\frac{\sqrt{3}-1}{2\sqrt{2}}\right)^2 = (4-2\sqrt{3})\frac{(\sqrt{3}-1)^2}{8} = \frac{(\sqrt{3}-1)^4}{8}$$

$$\therefore \text{(I)} \rightarrow \text{(Q)} ; \text{(II)} \rightarrow \text{(T)} ; \text{(III)} \rightarrow \text{(S)} ; \text{(IV)} \rightarrow \text{(P)}$$

